

2007

EPV 013 Webber Field Notes 2007

Charles Webber

Follow this and additional works at: <https://digital.kenyon.edu/honduras>



Part of the Archaeological Anthropology Commons

Recommended Citation

Webber, Charles, "EPV 013 Webber Field Notes 2007" (2007). *Four Valleys Archive*. Paper 96952.
<https://digital.kenyon.edu/honduras/96952>

This Field Notes is brought to you for free and open access by the Anthropology at Digital Kenyon: Research, Scholarship, and Creative Exchange. It has been accepted for inclusion in Four Valleys Archive by an authorized administrator of Digital Kenyon: Research, Scholarship, and Creative Exchange. For more information, please contact noltj@kenyon.edu.

PAREP 2007 TEST EXCAVATIONS:

Follow up to the 2006 survey to test pit and map earthen structures found in the west side of the valley to develop a rough chronology of occupation on that side of the valley.

The 2007 follow up to the 2006 rural survey is the testing of earthen mound sites mapped along the west bank of the Rio La Pita (sites 025, 027, 052), the northern end of the Rio La Pena (sites 053, 054, 055, 056, 057, 058, 059), and one large earthen mound located just south of El Cafetal (site 011). These sites range in size from medium sized village sites (s-025 with 17 structures) to smaller hamlets (s-053 with 4 structures). The goal of the project is to understand the general temporal relationship between these sites and other sites in the valley. These sites are especially interesting because of the general acceptance that earthen mound structures date to the Preclassic period. If these sites do in fact follow that general trend then we could have the first evidence of three tiered Preclassic settlement hierarchy in any valley in the southeast Maya zone.

My project will involve heading out with 3 other local Honduran workers, Cheppy, Tino, and Victor, to map each site and excavate a series of test pits in order to find diagnostic ceramics. Our excavations will focus on what appears to be the edges of the structures in order to find any possible midden deposits or other trash deposits located around the structures. I wanted to stay off of the so as to not expose any potential architectural features or structure fill. Exposing architectural features would require more extensive documentation and my goal was to not find that type of feature but to move through as many test pits as possible in the quickest amount of time. The test pits themselves will average around 50x50 cm in size and will descend between 40 and 60 cm or until we seem to hit sterile clay. The test pits will be located on the maps with an 'X' denoting their general location.

This project will be conducted under **OPERATION 11**

The SUBOP number will correspond with the site number. For example at site 055 the first lot excavated has the OP/SUBOP/LOT designation of 11/055/1. This means that the

SUBOP designations do not increase sequentially from 1 but change based on the site where we excavated the test pit.

The lot number corresponds with the number of lots excavated at a site and do increase sequentially from one for each SUBOP.

The Excavation Unit (EU) will always be 'A' unless we hit a floor or other such architectural feature in a unit that would make us want to split the lot into two. I don't foresee that ever happening because we are not locating the test pits on the structures.

The maps we will make are quick compass and tape maps at a scale of either 1 cm = 5 meters or 1 cm = 10 meters, depending on the size of the site. While these maps are not wonderfully accurate they do give a good idea of the site size and the location of the structures. These maps will be used to provide a picture of the nature of the site layout and extent of settlement at these smaller sites.

The quick test excavations and compass and tape maps will greatly increase our understanding of the nature of the settlement of the valley since nothing is known about these sites on the western side of the valley. If these sites do in fact prove to be datable to the Preclassic period then it is likely that they are the only clustering of small village sites dating to the Preclassic known for the southeastern Maya zone. They will greatly increase our understanding of settlement within the southeast Maya zone and within the valley itself since most Preclassic investigations have focused on the large sites of Orquedias and El Guayabal. However, even if they prove to be classic period in date of occupation then they will increase our understanding of the nature and extent of the Classic period settlement in the valley since much of the excavation up to this point has focused on the large settlement of El Cafetal and El Paraiso located in the southeast portion of the valley.

May 18.2007:

We finally got permission from someone to head out into the field. Marcello and Santiago have not seen the Mayor yet but we decided to ask Pedro Elder Aguiler who owns the land on which we found sites 025, 027, and 052. We talked to him last night and he said that there was no problem with us testing the sites on his land. These sites are located on the west bank of the Rio La Pita almost directly across the river from Las Orquideas. These sites could prove to be in an interesting location as they are earthen mound sites located geographically between Las Orquideas and the cluster of sites located along the Rio La Pena.

Since I had drawn maps of these sites last year we focused on test pitting around the structures. I wanted to get at least 5 test pits into the ground at each site meaning that we would have to dig 15 in one day, tough but not impossible. So let stop discussing this and get to work!

SITE 025 (EL ZACATAL)

11/025/1:

Unit Size: 50 x 50 cm; Unit Depth: 0-45 cm BGS; Found: ceramics

Test pit was located between structures 1 and 2.

Dug through dark brown loamy / friable top soil down to a orange/brown hard clay located at about 40 cm BGS

11/025/2:

Unit Size: 50 x 50 cm; Unit Depth: 0-60 cm BGS; Found: ceramics

Test pit was located on the west side of structure 6

Dug through dark brown loamy / friable top soil down to a orange/brown hard clay located at about 55 cm BGS.

11/025/3

Unit Size: 60x100 cm; Unit Depth: 0-60 cm BGS; Found: ceramics

Test pit located on the south side of structure 9.

Dug through dark brown loamy / friable top soil down to a orange/brown hard clay.

11/025/4

Unit Size: 50x50 cm; Unit Depth: 0-50 cm BGS; Found: nothing

Test pit located on west side of structure 8.

Dug through dark brown loamy / friable top soil down to a orange/brown hard clay.

11/025/5

Unit Size: 120x60 cm; Unit Depth: 0-50 cm BGS; Found: ceramics

Test pit located on west side of structure 12.

Dug through dark brown loamy / friable top soil down to a orange/brown hard clay.

11/025/6

Unit Size: 50x50 cm; Unit Depth: 0-50 cm BGS; Found: ceramics, obsidian

Test pit located on south side of structure 17 at the far southern end of the site.

Dug through dark brown loamy / friable top soil down to a orange/brown hard clay.

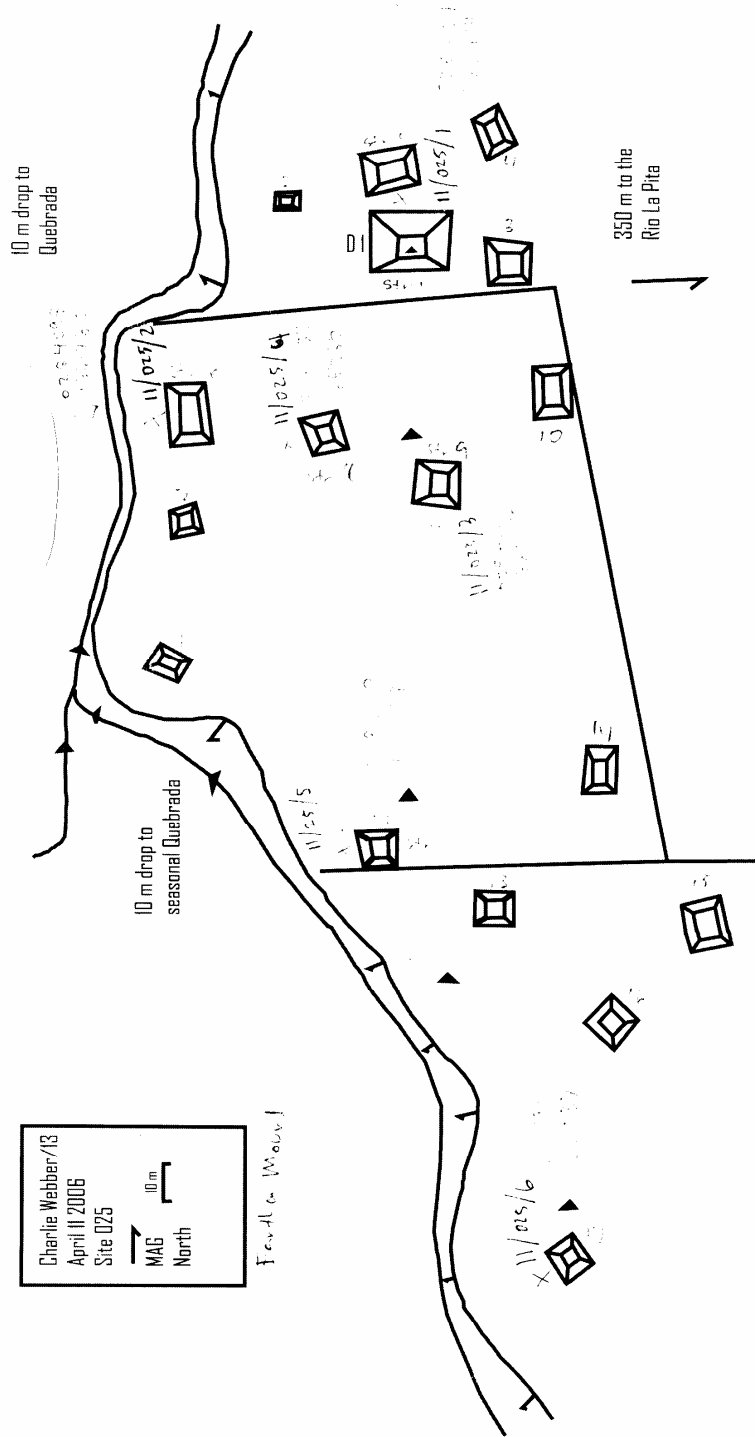

SITE 027

11/027/1

Unit Size: 60x60 cm; Unit Depth: 0-60 cm BGS; Found: ceramics, obsidian

Test pit located on east side of structure 5.

Dug through dark brown loamy / friable top soil down to a beige brown hard clay.

11/027/2

Unit Size: 70x50 cm; Unit Depth: 0-25 cm BGS; Found: ceramics

Test pit located along northwest side of structure 4.

Dug through dark brown loamy / friable top soil down to a beige brown hard clay.

11/027/3

Unit Size: 50x50 cm; Unit Depth: 0-40 cm BGS; Found: ceramics

Test pit located on south side of structure 2.

Dug through dark brown loamy / friable top soil down to a beige brown hard clay.

11/027/4

Unit Size: 60x60 cm; Unit Depth: 0-45 cm BGS; Found: nothing

Test pit located on west side of structure 7.

Dug through dark brown loamy / friable top soil down to a beige brown hard clay.

11/027/5

Unit Size: 70x40 cm; Unit Depth: 0-25 cm BGS; Found: ceramics, chert, obsidian

Test pit located on the north side of structure 9.

Dug through dark brown loamy / friable top soil down to a beige brown hard clay.

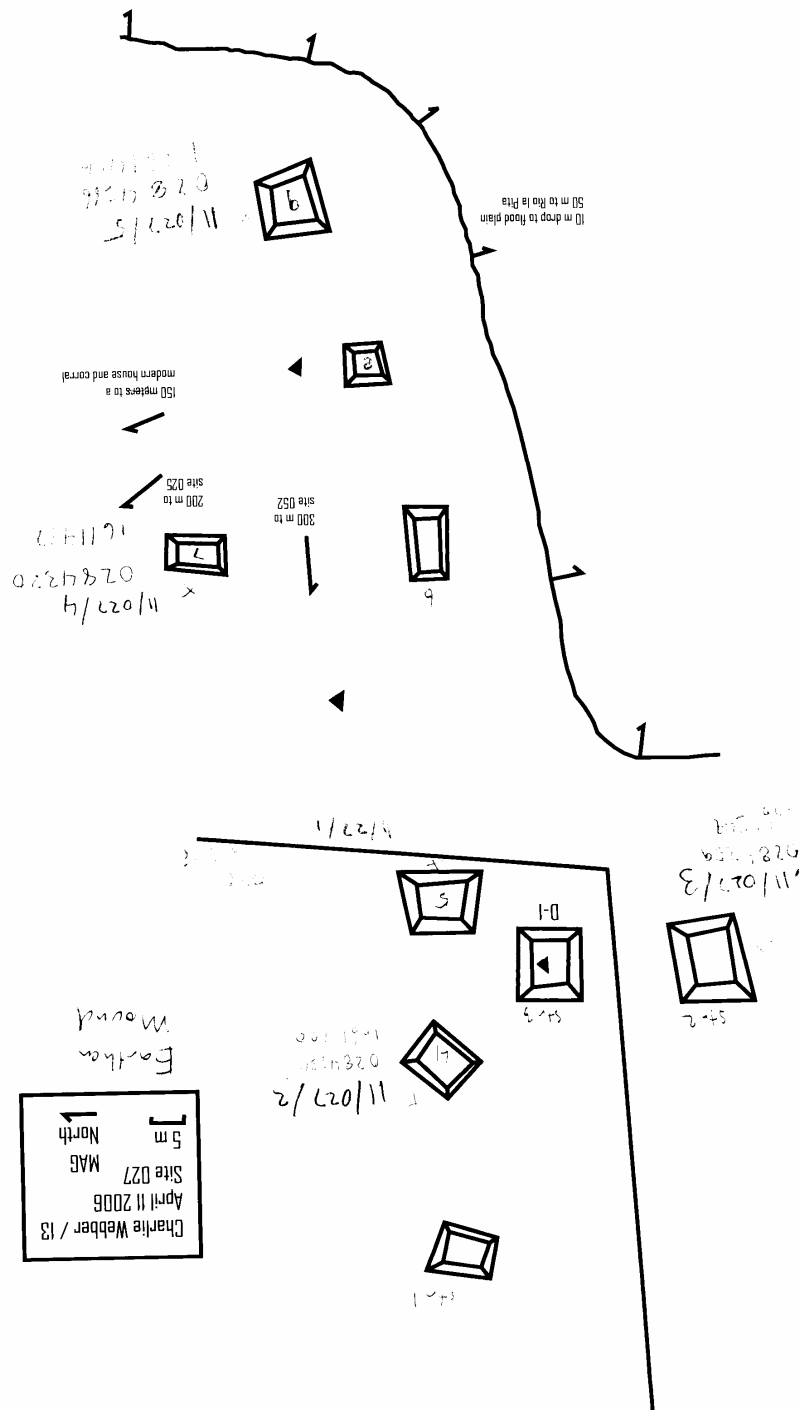

SITE 052

11/052/1

Unit Size: 50x60 cm; Unit Depth: 0-50 cm BGS; Found: ceramics

Test pit located on the southern end of structure 1.

Dug through dark brown loamy / friable top soil to an orange brown loamy clay.

11/052/2

Unit Size: 50x70 cm; Unit Depth: 0-60 cm BGS; Found: ceramics, BJ

Test pit located on east side of structure 1.

Dug through dark brown loamy / friable top soil to an orange brown loamy clay.

11/052/3

Unit Size: 120x75 cm; Unit Depth: 0-50 cm BGS; Found: BJ, obsidian, toba

Test pit located on west side of structure 1.

Dug through dark brown loamy / friable top soil to an orange brown loamy clay.

11/052/4

Unit Size: 60x50 cm; Unit Depth: 0-40 cm BGS; Found: ceramics

Test pit located on north side of structure 3.

Dug through dark brown loamy / friable top soil to an orange brown clay.

11/052/5

Unit Size: 55x60 cm; Unit Depth: 0-50 cm BGS; Found: nothing

Test pit located on the north side of structure 5.

Dug through dark brown loamy / friable top soil to an orange brown clay.

Today was very successful. We were able to excavate a total of 16 test pits, 6 from site 025, 5 from 027, and 5 from 052. From these excavations we found a decent number of ceramics and also found some diagnostic rim sherds so we should be able to get a general idea of when the site was occupied.

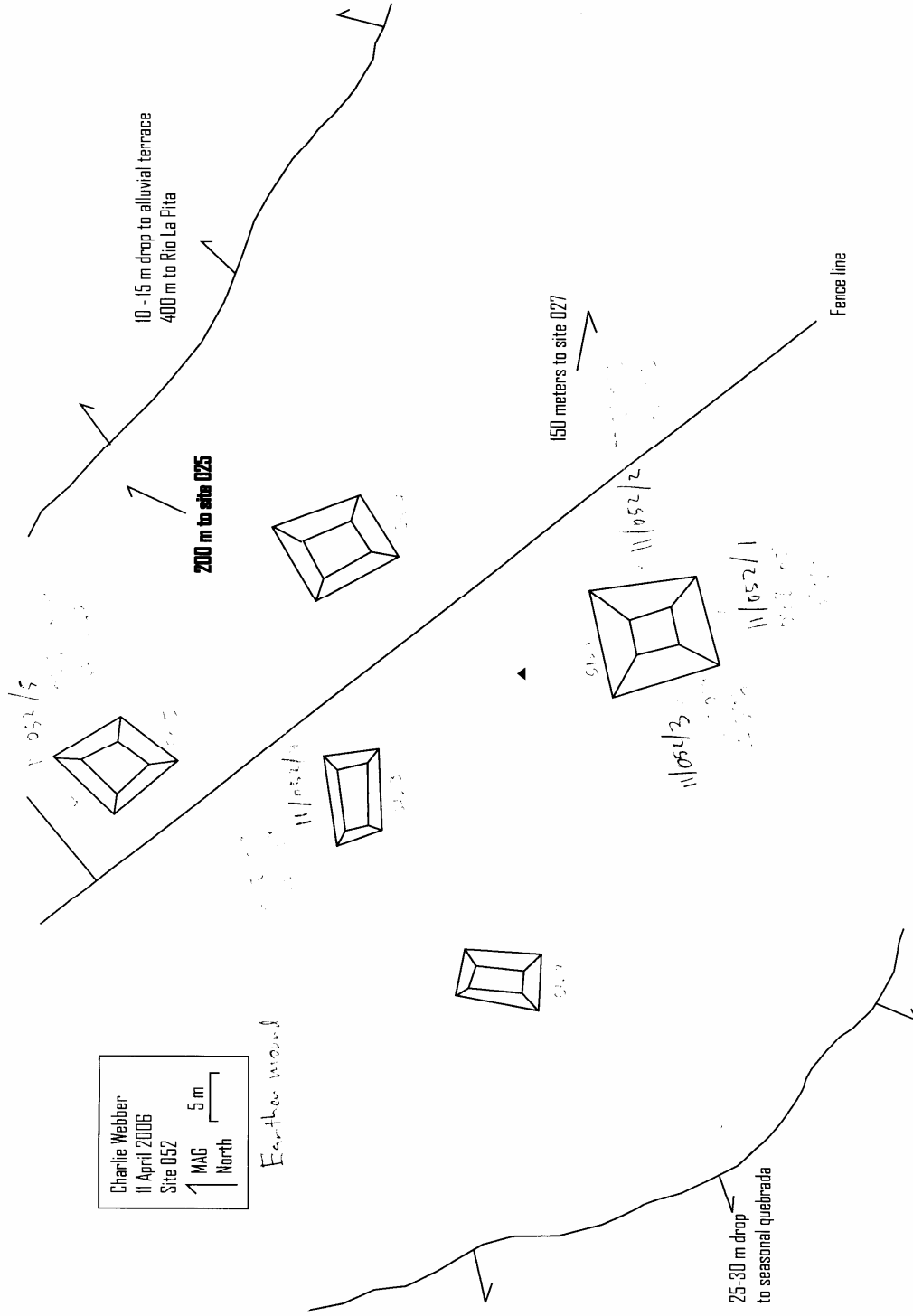

Charlie Webber
11 April 2006
Site 052
MAG
North

Earthen mound

200 m to site 025

150 meters to site 027

Fence line

25-30 m drop
to seasonal quebrada

10-15 m drop to alluvial terrace
400 m to Rio La Pita

11/052/5

11/054/3

11/052/2

11/052/1

11/054/3

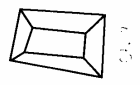
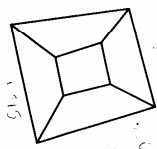
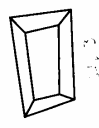
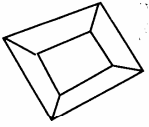
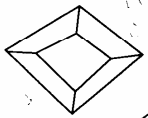

May 19, 2007

Well it was nice to get another day of work in this week today. Today I found out that the land that I had wanted to go on was not the Mayors land after all, it was still the land of Jorge Espana like it had been last year – ohh well. Luckily this guy knew us and had let us on his land last year so we don't have to spend a whole other day looking for him.

Today we are going to test and map site 056. This site is a river cobble site so it is not as interesting to me as all of the others in the area which are all earthen. However, it will be good to get a sample from here to compare to the other sites that we will test since river cobble sites should be clearly Classic period sites. This site seems to be the only river cobble site located along the Rio La Pena till you walk about 2-3 kms to the south when you reach the Las Penas Site.

SITE 056

11/056/1

Unit Size: 60x60 cm; Unit Depth: 0-40 cm BGS; Found: ceramics, BJ, obsidian

Test pit located on northwest side of structure 2.

Dug through dark brown loamy / friable top soil to a beige brown clay.

11/056/2

Unit Size: 60x70 cm; Unit Depth: 0-20 cm BGS; Found: ceramics, obsidian

Test pit located on the west side of structure 5.

Dug through dark brown loamy / friable top soil to a beige brown clay.

11/056/3

Unit Size: 70x60 cm; Unit Depth: 0-35 cm BGS; Found: ceramics

Test pit located on west side of structure 10.

Dug through dark brown loamy / friable top soil to a beige brown clay.

461510

461510

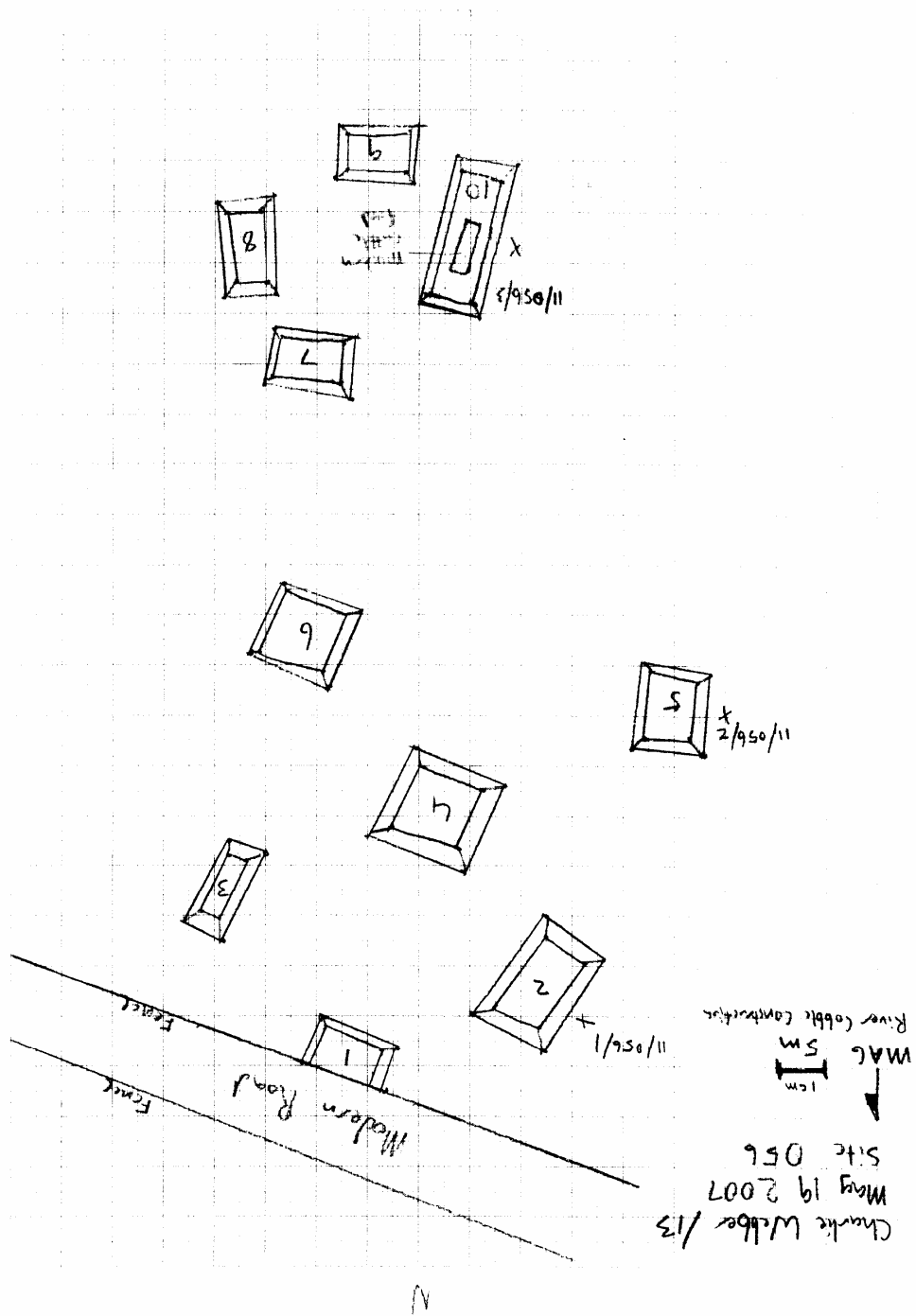

SITE 057

11/057/1

Unit Size: 70x50 cm; Unit Depth: 0-50 cm BGS; Found: ceramics

Test pit located on the east side of structure 5.

Dug through hard brown loamy top soil to a hard brown clay.

11/057/2

Unit Size: 60x60 cm; Unit Depth: 0-35 cm BGS; Found: ceramics

Test pit located on west side of structure 5.

Dug through hard brown loamy top soil to a hard brown clay.

11/057/3

Unit Size: 70x70 cm; Unit Depth: 0-30 cm BGS; Found: ceramics

Test pit located on north side of structure 4.

Dug through hard brown loamy top soil to a hard brown clay.

11/057/4

Unit Size: 60x60 cm; Unit Depth: 0-40 cm BGS; Found: nothing

Test pit located on the north side of structure 3.

Dug through hard brown loamy top soil to a hard brown clay.

11/057/5

Unit Size: 70x60 cm; Unit Depth: 0-30 cm BGS; Found: ceramics

Test pit located on south side of structure 1.

Dug through hard brown loamy top soil to a hard brown clay.

Today was a very productive day. We were able to map and excavate 3 test pits at site 056 before lunch and then excavate 5 test pits at site 057 before heading home. Site 057 is an earthen mound site with a fairly large structure at its northern end that overlooks the

junction of the Pita and the Pena while also having a commanding view of Cerro Azule. I think that we were able to find some good diagnostic sherds from this site though as usual the test pit that came up empty was the one that I dug! I am going to try and convince Clarissa and Roberto to come out the this site tomorrow to help me map it so I can get a jump start on next week...it shouldn't take too long to map it with more than just Cheppy and I, and it will be a good opportunity for them to learn how to map with a compass and a tape since it sounds like they have not done that before.

May 20, 2007

Despite the fact that it is the usual day of rest I was able to convince Cheppy, Clarissa, and Roberto to come out to site 057 to make the map. We started at about 9 and I first showed Clarissa and Roberto how to measure the angle and transfer that to the paper then I just got to relax and run the tape while they ran the show, a nice change of pace for me.

The map ended up looking great and I think that everybody had a good time and we finished early, by about 12:30 and were home by lunch.

Later that afternoon I washed some of the sherds that I had found to let Marcello look at them and he was happy because their were some nice diagnostic rim sherds in our collections.

85/44
 15/35
 74/385
 77/27

47 1510

47 1510
 85/44
 15/35
 74/385
 77/27

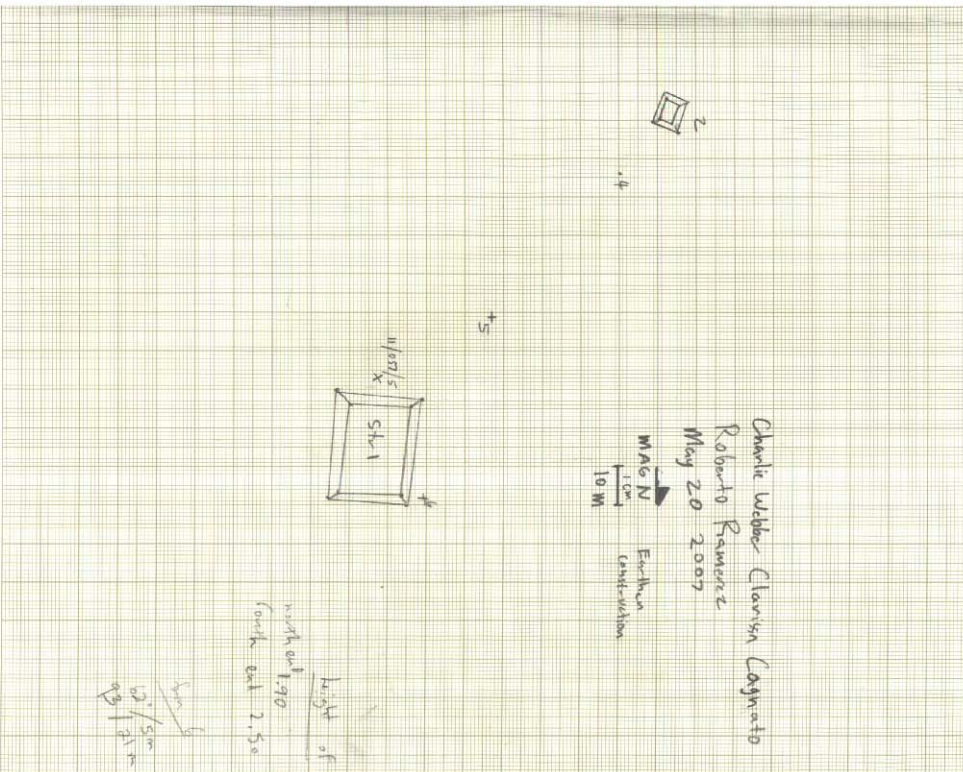
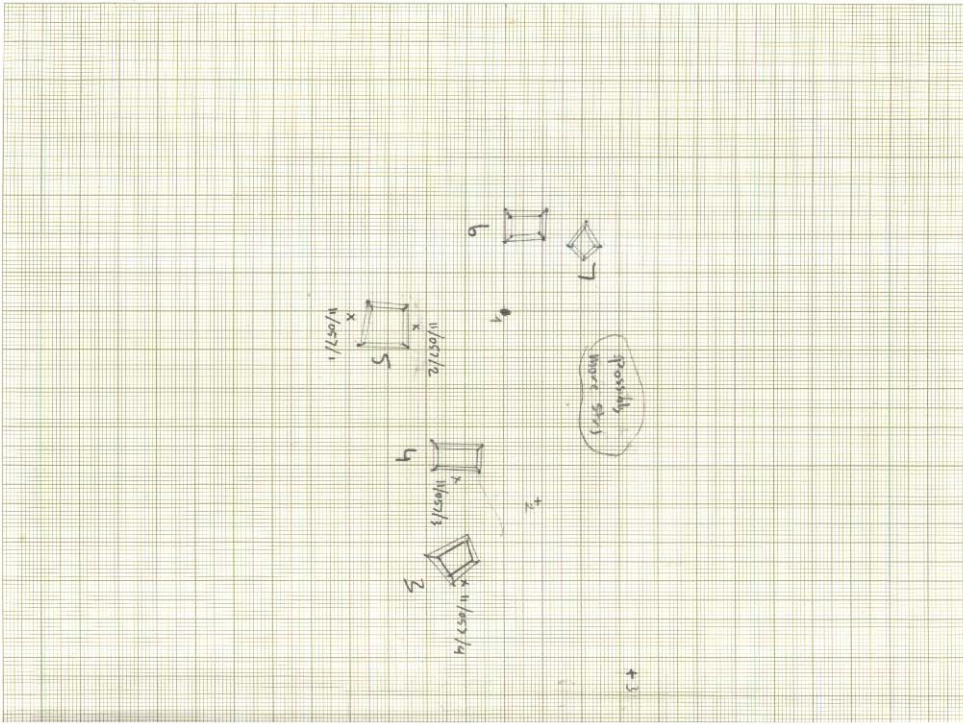

May 21, 2007

Today the plan was to excavate test pits and make a map at site 058. This site is located at the top of the hill overlooking site 057 to the north. Site 058 is composed of several small earthen mounds and one possibly large earthen mound on the northeast corner of the site. By testing the sides of these structures we hope to come across some diagnostic sherds.

SITE 058

11/058/1

Unit Size: 70x60 cm; Unit Depth: 0-40 cm BGS; Found: ceramics, obsidian

Test pit located along the southwest corner of structure 1.

Dug through dark brown loamy / friable top soil down to a lighter brown hard clay.

11/058/2

Unit Size: 70x60 cm; Unit Depth: 0-40 cm BGS; Found: ceramics, obsidian

Test pit located along the south side of structure 4.

Dug through dark brown loamy / friable top soil down to a lighter brown hard clay.

11/058/3

Unit Size: 70x50 cm; Unit Depth: 0-40 cm BGS; Found: ceramics

Test pit located along the west side of structure 5.

Dug through dark brown loamy / friable top soil down to a lighter brown hard clay.

11/058/4

Unit Size: 50x60 cm; Unit Depth: 0-40 cm BGS; Found: ceramics

Test pit located along the east side of structure 3.

Dug through dark brown loamy / friable top soil down to a lighter brown hard clay.

11/058/5

Unit Size: 110x110 cm; Unit Depth: 0-50 cm BGS; Found: ceramics, chert, obsidian, ground stone.

Test pit located along the south side of structure 2.

Dug through dark brown loamy / friable top soil down to a lighter brown hard clay.

Test pit started small like the rest of the pits but was expanded because of the relatively high density of ceramics found in the location compared to the other locations.

11/058/6

Unit Size: 70x60 cm; Unit Depth: 0-40 cm BGS; Found: ceramics

Test pit located along the north side of structure 2.

Dug through dark brown loamy / friable top soil down to a lighter brown hard clay.

11/058/7

Unit Size: 70x50 cm; Unit Depth: 0-30 cm BGS; Found: ceramics

Test pit located along the east side of structure 7.

Dug through dark brown loamy / friable top soil down to a lighter brown hard clay.

Seems to have been modern disturbances in this location. Not much modern trash was seen but the remains of an oven for cooking dulce was dug into the structure.

with ground
the DST directly above



North Webster / 13
ay 21 2007

01/00/00	08/1/00	71/1/00	02/04/00	23/1/00	28/1/00
02/00/00	09/1/00	02/02/00	24/1/00	24/1/00	28/1/00
03/00/00	10/1/00	03/03/00	25/1/00	25/1/00	29/1/00
04/00/00	11/1/00	04/04/00	26/1/00	26/1/00	30/1/00
05/00/00	12/1/00	05/05/00	27/1/00	27/1/00	31/1/00
06/00/00	13/1/00	06/06/00	28/1/00	28/1/00	31/1/00
07/00/00	14/1/00	07/07/00	29/1/00	29/1/00	31/1/00
08/00/00	15/1/00	08/08/00	30/1/00	30/1/00	31/1/00
09/00/00	16/1/00	09/09/00	31/1/00	31/1/00	31/1/00
10/00/00	17/1/00	10/10/00	31/1/00	31/1/00	31/1/00
11/00/00	18/1/00	11/11/00	31/1/00	31/1/00	31/1/00
12/00/00	19/1/00	12/12/00	31/1/00	31/1/00	31/1/00

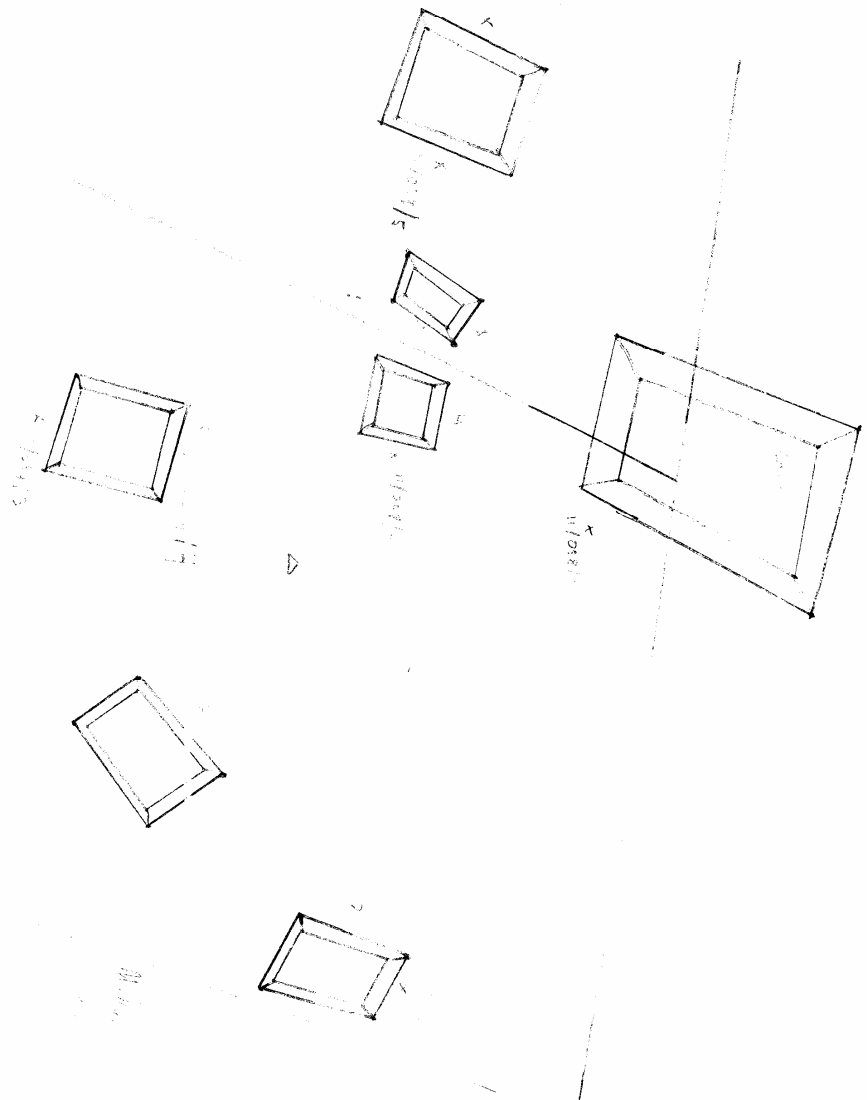

SITE 059

May 21, 2007 part 2. after lunch I figured we had enough ceramics from site 058 and we headed up to site 059 located about 400 meters to the south. It turns out that site 059 is located on the Mayors land so it was good that we had gotten permission from him after all. Unfortunately, the Mayor had decided to plow the field in order to grow secate to feed his cow so the site was not in very good shape and will be hard to map tomorrow. This afternoon we will begin to excavate some test pits. Because of the plowing we were unable to discern clear stratigraphic layers, it looked like the plows had descended at least 50 cm BGS.

11/059/1

Surface collection. Found: ceramics, obsidian, chert

Since the land had been plowed it had churned up a number of ceramics that we could see on the ground so we spent some time collecting them.

11/059/2

Unit Size: 70x50 cm; Unit Depth: 0-60 cm BGS; Found: ceramics

Test pit located along the north side of structure 1.

11/059/3

Unit Size: 60x50 cm; Unit Depth: 0-50 cm BGS; Found: nothing

Test pit located on the south side of structure 1.

11/059/4

Unit Size: 70x60 cm; Unit Depth: 0-40 cm BGS; Found: nothing

Test pit located along the west side of structure 1.

11/059/5

Unit Size: 70x60 cm; Unit Depth: 0-30 cm BGS; Found: ceramics

Test pit located on the south side of structure 2.

11/059/6

Unit Size: 100x100 cm; Unit Depth: 0-40 cm BGS; Found: ceramics

Test pit located on the north side of structure 2.

11/059/7

Unit Size: 60x60 cm; Unit Depth: 0-60 cm BGS; Found: ceramics

Test pit located on the west side of structure 6.

3/21/07
2007/24
28/30

10/1/07
24/27
21/24
23/24
21/24

10/1/07
17/18
16/17
15/16
14/15

11/05/08
11/05/08

11/05/08
11/05/08
11/05/08
11/05/08

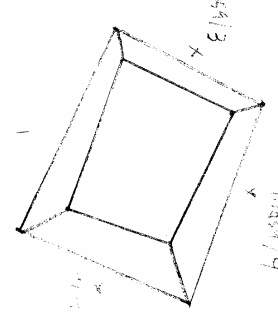
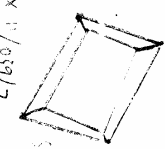
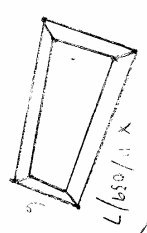
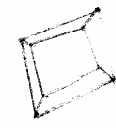
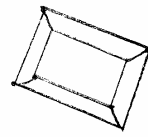

Charles Blabber / 112
May 22 2007



See you on the road
So far so good
See you on the road
See you on the road
See you on the road
See you on the road

May 22, 2007

Hello and good morning. Today started off a bit slower than usual, I don't think that we got to the site till about 9:30 which was fine by me since we had stayed up late talking to Ellen since she arrived last night. Today we are heading back to site 059 to conduct a few more test pits and draw the site map.

11/059/8

Unit Size: 65x70 cm; Unit Depth: 0-45 cm BGS; Found: ceramics

Test pit located on the west side of structure 4.

11/059/9

Unit Size: 70x70 cm; Unit Depth: 0-40 cm BGS; Found: ceramics

Test pit located on the south side of structure 8.

SITE 055

May 22, 2007 part 2. We finished the map and our two more test pits before lunch so we walked back across the river to site 055. there was a nice shade tree at this site so we camped under it for lunch where we were watched closely by the cows. After lunch we got to work excavating test pits around the site.

11/055/1

Unit Size: 45x60 cm; Unit Depth: 0-40 cm BGS; Found: ceramics

Test pit located on the north side of structure 1.

Excavated through a friable dark brown top soil to a hard orange brown clay.

Area surrounding structure 1 was milpa of corn and beans, while the rest of the site was located in cattle pasture.

11/055/2

Unit Size: 60x70 cm; Unit Depth: 0-50 cm BGS; Found: ceramics

Test pit located on the west side of structure structure1.

Excavated through a friable dark brown top soil to a hard orange brown clay.

11/055/3

Unit Size: 40x60 cm; Unit Depth: 0-35 cm BGS; Found: ceramics

Test pit located on the south side of structure 1.

Excavated through a friable dark brown top soil to a hard orange brown clay.

11/055/4

Unit Size: 70x60 cm; Unit Depth: 0-40 cm BGS; Found: ceramics

Test pit located on the west side of structure 3.

Excavated through a friable dark brown top soil to a hard orange brown clay.

11/055/5

Unit Size: 90x50 cm; Unit Depth: 0-50 cm BGS; Found: ceramics

Test pit located on the west side of structure 2.

Excavated through a friable dark brown top soil to a hard orange brown clay.

11/055/6

Unit Size: 70x70 cm; Unit Depth: 0-50 cm BGS; Found: ceramics

Test pit located on the west side of structure 4.

Excavated through a friable dark brown top soil to a hard orange brown clay.

46 1/2 / 17 1/2 50 1/2 / 17 1/2
 52 1/2 / 32 1/2 26 1/2 / 17 1/2
 46 1/2 / 17 1/2 16 1/2 / 17 1/2
 52 1/2 / 32 1/2 23 1/2 / 28 1/2
 22 1/2 / 10 1/2 23 1/2 / 17 1/2
 42 1/2 / 15 1/2 42 1/2 / 15 1/2
 46 1/2 / 17 1/2 46 1/2 / 17 1/2
 23 1/2 / 10 1/2 49 1/2 / 15 1/2
 30 1/2 / 17 1/2

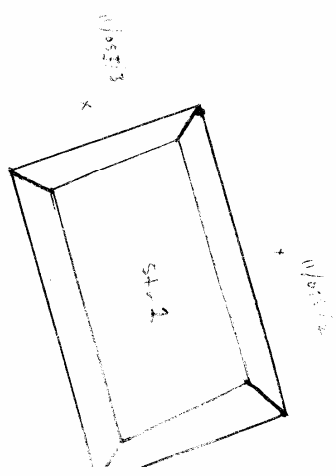
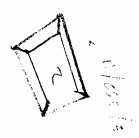
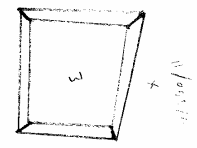
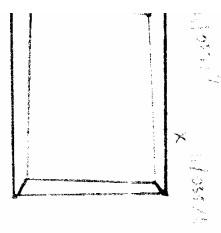

D1

D2

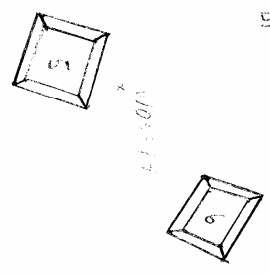

Check reference
 May 24 2007
 -055
 MASII
 Escalator stairs

Well today ended in fairly uncertain circumstances because Jorge Espana came out to greet us by yelling at us for not getting permission to be on his land and we were told to get off. He was afraid that we would find something cool which would lead the institute to take away his land which would cause him to go bankrupt. I had thought that Marcello had gone to talk to him a few days ago to get his permission but apparently he had not and now the guy was mad. So we packed up and drove home and when I told Marcello he was confused also because he had thought that he had gotten permission for us to be there. But he went back to the Finca San Jorge to talk to the man and get things straightened out. We have enough ceramics from this site to make a good determination of the dates of occupation but I was going to make a map of the site tomorrow and then move on the two more sites that I wanted to investigate further south along the river. So hopefully Marcello gets everything straightened out.

May 23, 2007

Hello and good morning. Although it's now closer to the afternoon when we finally got started. Yesterday Marcello had gone to talk with Jorge Espana at the Finca San Jorge to get things straightened out and when he returned he was confident that he had gotten permission for us to be let in today. But apparently that was not the case. When we arrived the wife of the caretaker would not let us into the property because she had been told not to. We thought that this was strange so waited for a while to see if the caretaker would return but he never did. We were finally able to convince the lady to call her husband who could then call Jorge and get everything straightened out since he had told Marcello yesterday that we could go back in today. However to our surprise when she did this Jorge said no, we could not go back in. Confused we all returned to El Paraiso and I talked to Marcello who was also confused but we decided that I would head out to site 11, a large earthen mound located just to the south of El Cafetal to test that site and he would try and track down Jorge and see what the deal was.

Site 11 is an earthen mound located about 400 meters to the south of El Cafetal that Ellen and Marcello had always wanted to test but had never had the time to do so since I was testing earthen mound sites this one was a good one to go to occupy me for a day when I couldn't get into the area that I wanted to study. The mound is located in the middle of corn milpa. It looks very similar to the large mounds located at sites 055, 057, and 058 in size and shape which leads me to believe that there may be other small earthen mounds located close by that have been destroyed or at least obscured by the farming that has taken place on the land for many years since the mounds at the other sites were often less than a meter tall.

The test pits that we excavated around the structure were located generally on the North, northeast, east, southeast, south, southwest, west, and northwest sides of the structure.

SITE 011

11/011/1

Unit Size: 60x60 cm; Unit Depth: 0-60 cm BGS; Found: ceramics

Test pit located on the southeast side of structure 1.

The test pit was dug through dark brown friable topsoil to a hard dark brown clay below.

11/011 /2

Unit Size: 90x60 cm; Unit Depth: 0-40 cm BGS; Found: ceramics, obsidian

Test pit located on the southwest side of structure 1.

The test pit was dug through dark brown friable topsoil to a hard dark brown clay below.

11/011/3

Unit Size: 50x60 cm; Unit Depth: 0-35 cm BGS; Found: ceramics

Test pit is located on the west side of structure 1.

The test pit was dug through dark brown friable topsoil to a hard dark brown clay below.

11/011/4

Unit Size: 70x60 cm; Unit Depth: 0-55 cm BGS; Found: ceramics

Test pit located on the east side of structure 1.

The test pit was dug through dark brown friable topsoil to a hard dark brown clay below.

11/011/5

Unit Size: 80x70 cm; Unit Depth: 0-55 cm BGS; Found: ceramics, obsidian

Test pit is located on the northeast side of structure 1.

The test pit was dug through dark brown friable topsoil to a hard dark brown clay below.

11/011/6

Unit Size: 70x60 cm; Unit Depth: 0-50 cm BGS; Found: ceramics

Test pit is located on the north side of structure 1.

The test pit was dug through dark brown friable topsoil to a hard dark brown clay below.

11/011/7

Unit Size: 80x50 cm; Unit Depth: 0-50 cm BGS; Found: ceramics, obsidian

Test pit is located on the northwest side of structure 1.

The test pit was dug through dark brown friable topsoil to a hard dark brown clay below.

11/011/8

Unit Size: 60x70 cm; Unit Depth: 0-50 cm BGS; Found: ceramics

Test pit is located on the south side of structure 1.

The test pit was dug through dark brown friable topsoil to a hard dark brown clay below.

May 24, 2007

Good morning. Crisis averted! Today we were finally able to return to Jorge Espana's land inside of the Finca San Jorge. Marcello went and talked to him yesterday afternoon to see what was up and although he didn't seem to be too happy that he was not able to shake off the stubborn gringos he did give us permission to go back onto his land to finish my last two days of work. This morning we are going to quickly create a map for site 055 and head south for about 300 meters to site 054 and try and finish that site completely in the afternoon.

11/055/7

Unit Size: 60x60 cm; Unit Depth: 0-50 cm BGS; Found: ceramics, obsidian

Test pit located on the south side of structure 4.

Excavated through a friable dark brown top soil to a hard orange brown clay.

11/055/8

Unit Size: 60x60 cm; Unit Depth: 0-40 cm BGS; Found: ceramics, obsidian

Test pit located on the west side of structure 5.

Excavated through a friable dark brown top soil to a hard orange brown clay.

May 24, 2007 part two.

Well we were able to finish up the mapping and test pitting for site 055 in record time and after snack we headed over to site 054 to try and finish mapping and test pitting the site today. Site 054 is a small site with very small earthen mounds so it shouldn't take long to map and there is very little to test.

SITE 054

11/054/1

Unit Size: 70x60 cm; Unit Depth: 0-55 cm BGS; Found: ceramics, obsidian

Test pit located on the west side of structure 3.

Test pit was excavated through brown topsoil to hard orange/brown clay.

11/054/2

Unit Size: 60x60 cm; Unit Depth: 0-40 cm BGS; Found: ceramics, obsidian

Test pit located on the southwest side of structure 7.

Test pit was excavated through brown topsoil to hard orange/brown clay.

11/054/3

Unit Size: 50x50 cm; Unit Depth: 0-30 cm BGS; Found: ceramics, obsidian

Test pit located on the northwest side of structure 5.

Test pit was excavated through brown topsoil to hard orange/brown clay.

11/054/4

Unit Size: 50x50 cm; Unit Depth: 0-40 cm BGS; Found: ceramics

Test pit located on the southeast side of structure 5.

Test pit was excavated through brown topsoil to hard orange/brown clay.

11/054/5

Unit Size: 70x60 cm; Unit Depth: 0-45 cm BGS; Found: ceramics, obsidian, chert

Test pit located on the northeast side of structure 7.

Test pit was excavated through brown topsoil to hard orange/brown clay.

11/054/6

Unit Size: 60x40 cm; Unit Depth: 0-40 cm BGS; Found: ceramics

Test pit located on the east side of structure 8.

Test pit was excavated through brown topsoil to hard orange/brown clay.

11/054/7

Unit Size: 70x60 cm; Unit Depth: 0-65 cm BGS; Found: ceramics, obsidian

Test pit located on the northwest side of structure 1.

Test pit was excavated through brown topsoil to hard orange/brown clay.

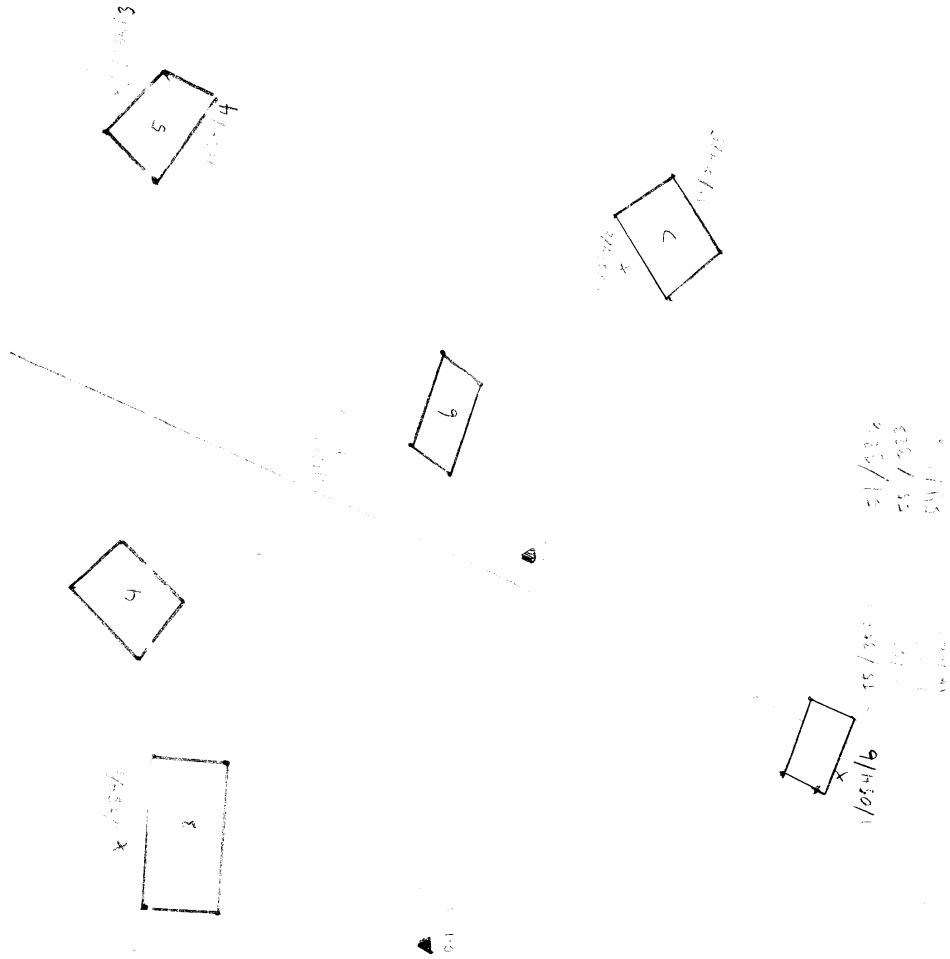

(str) X 11/05/17

Charlie Webster / 13
May 24 2007

3-215

1000000

1000
500

May 24 2007

1000	20/2000	20/2000	20/2000
1000	35/2000	35/2000	35/2000
1000	20/2000	20/2000	20/2000
1000	20/2000	20/2000	20/2000

51/2000
55/2000
50/2000

15/2000
10/2000
10/2000

1/054/6
x

Today was a very productive day. We were able to finish two test pits and a map at site 055 and then seven test pits and a map at site 054. This leaves us only one site, site 053 to finish up tomorrow and then I will have tested all of the sites that I found last year along the Rio La Pena (not including the three sites that Ellen found at the southern end of the valley a few years earlier).

May 25, 2007

Good morning! Today is my last day in the field and we are heading over to the final site of this project, site 053, to map and test pit it today. This site is not part of the cluster of sites at the northern end of the Rio La Pena but is farther south, almost 2 kilometers farther south along the river. The site is composed of 4 obvious structures. I had seen more last year but I could not make them out definitively enough this year to map them because of the dense secate. The four structure are located on the north east end of a small vega bordered by the Pena to the south and a small quebrada (possibly a spring?) to the north. There is modern looting on the to largest structures at the site and there seems to be other disturbances in the rest of the vega possibly obscuring mounds. It almost looks as if someone had seen a number of columns of light coming from structures and had tried to destroy them to stop the light. So the plan is to make a map of the four definite structures and test for ceramics around them.

SITE 053

11/053/1

Unit Size: 60x70 cm; Unit Depth: 0-35 cm BGS; Found: ceramics

Test pit located on the west side of structure 2.

Test pits were excavated through hard dark brown friable topsoil to hard compact orange/brown clay

11/053/2

Unit Size: 60x70 cm; Unit Depth: 0-40 cm BGS; Found: ceramics, chert

Test pit located on the north side of structure 3.

Test pits were excavated through hard dark brown friable topsoil to hard compact orange/brown clay

26/54	26/63	3350/146	35/428
33/24	425/60	3850/144	4350/230
275/50	45/44	31/172	42/254
1/138	38/42	265/166	290/254

Charlie Webber / 13
 May 25 2007

S-053
 MAG N
 1 CM
 5 M

Earthen Mounds

Small stream - (Spring?)

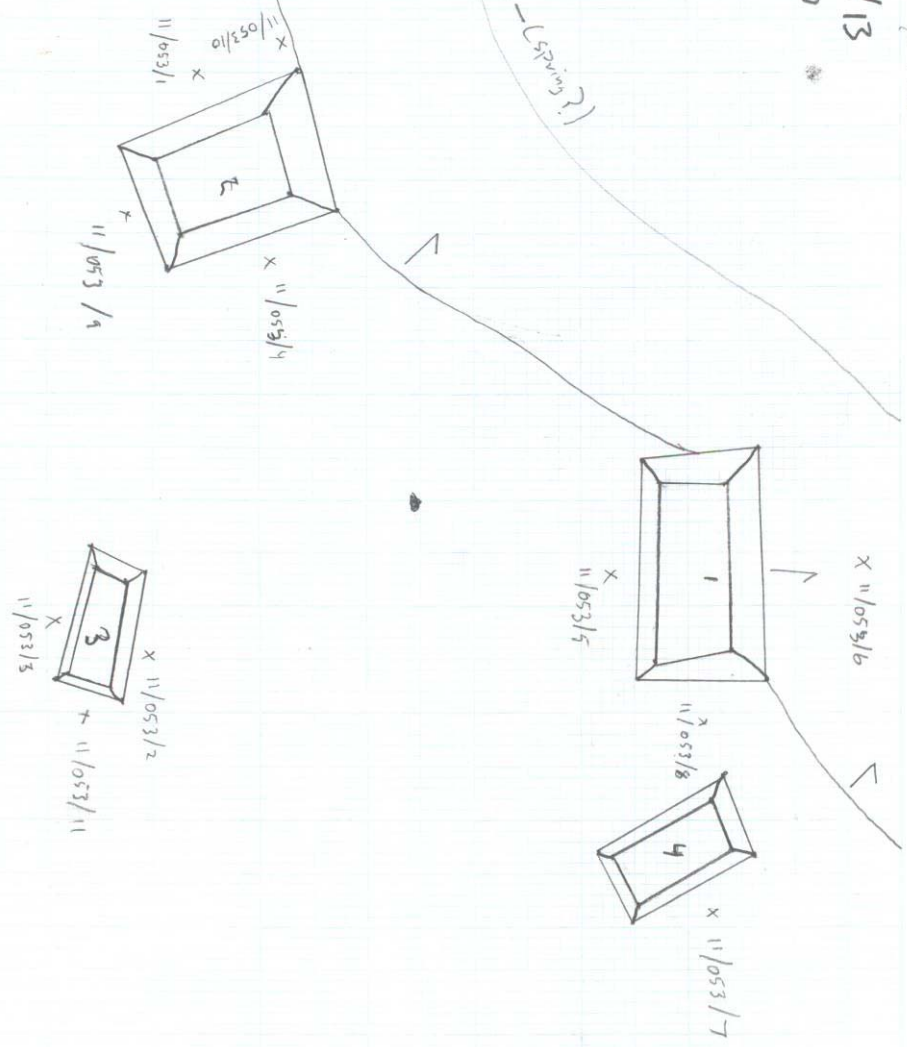

11/053/3

Unit Size: 60x60 cm; Unit Depth: 0-40 cm BGS; Found: ceramics

Test pit located on the south side of structure 3.

Test pits were excavated through hard dark brown friable topsoil to hard compact orange/
brown clay

11/053/4

Unit Size: 60x60 cm; Unit Depth: 0-30 cm BGS; Found: nothing

Test pit located on the east side of structure 2.

Test pits were excavated through hard dark brown friable topsoil to hard compact orange/
brown clay

11/053/5

Unit Size: 50x50 cm; Unit Depth: 0-45 cm BGS; Found: nothing

Test pit located on the south side of structure 1.

Test pits were excavated through hard dark brown friable topsoil to hard compact orange/
brown clay

11/053/6

Unit Size: 70x40 cm; Unit Depth: 0-45 cm BGS; Found: nothing

Test pit located on the north side of structure 1.

Test pits were excavated through hard dark brown friable topsoil to hard compact orange/
brown clay

11/053/7

Unit Size: 60x60 cm; Unit Depth: 0-30 cm BGS; Found: nothing

Test pit located on the east side of structure 4.

Test pits were excavated through hard dark brown friable topsoil to hard compact orange/
brown clay

11/053/8

Unit Size: 50x50 cm; Unit Depth: 0-50 cm BGS; Found: ceramics, chert

Test pit located on the east side of structure 1.

Test pits were excavated through hard dark brown friable topsoil to hard compact orange/brown clay

11/053/9

Unit Size: 50x50 cm; Unit Depth: 0-40 cm BGS; Found: ceramics, chert

Test pit located on the south end of structure 2.

Test pits were excavated through hard dark brown friable topsoil to hard compact orange/brown clay

11/053/10

Unit Size: 60x70 cm; Unit Depth: 0-45 cm BGS; Found: ceramics, obsidian

Test pit is located on the northwest corner of structure 2.

Test pits were excavated through hard dark brown friable topsoil to hard compact orange/brown clay

11/053/11

Unit Size: 60x60 cm; Unit Depth: 0-40 cm BGS; Found: obsidian

Test pit located on the eastern side of structure 3.

Test pits were excavated through hard dark brown friable topsoil to hard compact orange/brown clay

Well today ended as a nice but slightly frustrating day – we did a lot of work but did not find many ceramics and I don't think we found any diagnostic rim sherds. We found a bunch of chert but then also a nice obsidian blade so we will have to see if Cassandra can make any sense of the ceramics that we did find. However, we did a lot of good work, making the map and excavating 11 test pits.

I think the project turned out to be a very successful attempt to uncover the extent and occupation sequence in the far western portions of the valley. It seems, through preliminary ceramic examination by Ellen and Marcello that many of the sites date to the Preclassic period. The scalloped rim sherds and rim sherds shaped like commas and other punctuation are diagnostic of the Preclassic and hopefully those rims that were identified as such combined with the analysis of the pastes and other characteristics by Cassandra later this summer will shed more light onto the general date of occupation of these sites.

During the short duration of my project totaling only 8 days in the field I was able to excavate at 11 sites excavating a total of 74 test pits. We were also able to draw compass and tape site maps for 7 of the 11 sites. Sites 025, 027, and 052 already had site maps that I had made last year and site 011 was represented by a single mound. The ceramics that I collected should give us a good idea of the type of settlement located in this part of the valley, whether it is Preclassic, Classic, or whether it represents a mix of those two time periods.

Final Notes

Any final conclusions about the time period during which these sites, located in the western half of the valley, were occupied will have to wait for further ceramic analysis later this summer by Cassandra Bill. From preliminary analysis of a limited number of diagnostic rim sherds it looks like many of the sites could date to the Preclassic period giving the El Pariaso valley one of the highest Preclassic settlement densities anywhere in the southeast Maya zone.

This project was designed to provide PAREP general dates of occupation for these 11 sites. Because of the nature of rapid test pits it is unlikely much more could be said about the nature of the settlement beyond providing baseline data regarding the occupation of the sites. All of the test pits were located off of the structures and no obvious extra mural features (like a floor for example) were encountered. I purposely designed the project to look in possible refuse areas that are commonly located off of the back side of structures in this region. To do this I took my best guess as to the orientation of the mound in question and placed a test pit on the side that I thought might represent the rear of the structure. This resulted in varying degrees of success. A decent number of sherds were recovered from most sites which hopefully represents a sample large enough date with a fair degree of confidence.

Site 025

11/025/1-6

This site was mapped in 2006, when 17 earthen structures were mapped using a compass and tape. So my crew and I focused on test pitting and finding ceramics. This year, (2007) we put in 6 test pits in this site along structures 1, 6, 8, 9, 12, and 17. Every pit except the one along structure 8 yielded artifacts. Each pit descended through a dark friable loam topsoil to a reddish brown sterile soil level B consisting of a hard clay.

Site 027

11/027/1-5

This site was mapped in 2006, when 9 earthen structures were mapped using a compass and tape. So my crew and I focused on test pitting and finding ceramics. This year (2007) we put in 5 test pits in this site along structures 2, 4, 5, 7, and 9. Every pit except the one along structure 7 yielded artifacts. Each pit descended through a dark friable loam topsoil to a reddish brown sterile soil level B consisting of a hard clay.

Site 052

11/052/1-5

This site was mapped in 2006 when 5 earthen structures were mapped using a compass and tape. So my crew and I focused on test pitting and finding ceramics. This year (2007) we put in 5 test pits in this site, 3 around structure 1 and two others at structure 3 and structure 5. Every pit except the one along structure 5 yielded artifacts. Each pit descended through a dark friable loam topsoil to a reddish brown sterile soil level B consisting of a hard clay.

Site 056

11/056/1-3

Site 056 was found but not mapped during the 2006 field season. This year (2007) my team and I focused on excavating test pits and making a map. The map was made at a scale of 1 cm equals 5 meters using the compass and tape method, we mapped 10 river cobble structures. The 3 test pits, located along structures 2, 5, and 10, were excavated through dark brown loamy friable topsoil to a beige brown sterile clay. All three test pits yielded artifacts.

Site 057

11/057/1-5

Site 057 was found but not mapped during the 2006 field season. This year (2007) my team and I focused on excavating test pits and making a map. The map was made at a scale of 1 cm equals 10 meters using the compass and tape method, we mapped 7 earthen structures. The 5 test pits, located along structures 5, 4, 3, and 1, were excavated through dark brown loamy friable topsoil to a hard brown sterile clay. All of the test pits except the one along structure 3 yielded artifacts.

Site 058

11/058/1-7

Site 058 was found but not mapped during the 2006 field season. This year (2007) my team and I focused on excavating test pits and making a map. The map was made at a scale of 1 cm equals 5 meters using the compass and tape method, we mapped 7 earthen structures. The 7 test pits, located along structures 1, 2, 4, 5, 7, were excavated through dark brown loamy friable topsoil to a hard brown sterile clay. All of the test pits yielded artifacts, 11/058/5 held an especially large quantity of artifacts and may have been a midden of sorts.

Site 059

11/059/1-9

Site 059 was found but not mapped during the 2006 field season. This year (2007) my team and I focused on excavating test pits and making a map. The map was made at a scale of 1 cm equals 5 meters using the compass and tape method, we mapped 9 earthen structures. The 9 test pits, located along structures 1, 2, 4, 6, 8. All of the test pits except the two along structures 3 and 4 yielded artifacts. The site had been plowed in the year since I had been their last I believe so the soil was pretty well mixed up the top soil with the clay that had been previously located below the overburden.

Site 055

11/055/1-8

Site 055 was found but not mapped during the 2006 field season. This year (2007) my team and I focused on excavating test pits and making a map. The map was made at a scale of 1 cm equals 5 meters using the compass and tape method, we mapped 6 earthen structures. The 8 test pits, located along structures 1, 2, 3, 4, and 5, were excavated through dark brown loamy friable topsoil to a hard orange brown sterile clay. All of the test pits yielded artifacts. The site probably contained the largest earthen structures in this grouping along the Rio La Pena. Structure 1 was nearly 4 meters tall while structure 4 was also over two meters tall.

Original

Site 011

11/011/1-8

This site was one found by Ellen and Marcello a number of years ago but was never investigated so since I was investigating earthen mounds and had been locked out of Finca San Jorge for the day it was decided that this would be a good site to investigate. It is composed of one large earthen mound with no obvious associated structures located a few hundred meters south of El Cafetal. Our team focused on excavating 8 test pits around the structure a the north, south, east, and west, sides as well as the northeast, northwest, southeast, southwest sides. All of the test pits yielded artifacts.

Site 054

11/054/1-7

Site 054 was found but not mapped during the 2006 field season. This year my team and I focused on excavating test pits and making a map. The map was made at a scale of 1 cm equals 5 meters using the compass and tape method, we mapped 8 low lying earthen structures. The 7 test pits, located along structures 1, 3, 5, 7, and 8, were excavated through brown loamy topsoil to a hard orange brown sterile clay. All of the test pits yielded artifacts.

Site 053

11/053/1-11

Site 053 was found but not mapped during the 2006 field season. This year my team and I focused on excavating test pits and making a map. The map was made at a scale of 1 cm equals 5 meters using the compass and tape method, 4 earthen mound structures were mapped. The 11 test pits, located along structures 1, 2, 3, and 4, were excavated through dark brown loamy friable topsoil to a hard orange brown sterile clay. All of the test pits except test pit lots 4-7 yielded artifacts. Surprisingly few artifacts were encountered at this site.

The End!