

2009

## EPV 001 Bell Field Notes 2009

Ellen Bell

Follow this and additional works at: <https://digital.kenyon.edu/honduras>



Part of the Archaeological Anthropology Commons

---

### Recommended Citation

Bell, Ellen, "EPV 001 Bell Field Notes 2009" (2009). *Four Valleys Archive*. Paper 96964.  
<https://digital.kenyon.edu/honduras/96964>

This Field Notes is brought to you for free and open access by the Anthropology at Digital Kenyon: Research, Scholarship, and Creative Exchange. It has been accepted for inclusion in Four Valleys Archive by an authorized administrator of Digital Kenyon: Research, Scholarship, and Creative Exchange. For more information, please contact [noltj@kenyon.edu](mailto:noltj@kenyon.edu).

PAREP

Field Notes

2009

Ellen E. Bell

# 1

10 June 2009

2009-1-1

Arrived in SPS on 10 June, 2009, with May Hofstetter & Stefan Gruber. Went straight out to El Paraiso the Day.

11-14 June, 2009

Setting up house, computers, budgets, books, site sketch, etc.  
(See typed log for additional details.)

This season, we are hoping to complete at least limited tests on stands in the river zone to record out our Settlement Sample Sites of interest include those on the NE edge of the PAREP Spring area - S-34 to S-38. These south, roadside(?) stands are arranged in sand groups & should let us get an idea of the nature of tudy soil settlement inside the valley that dates to the Late Classic period. All of the stands have stones visible on the surface, so we have tentatively identified them as Late Classic settlement, but this, of course, will have to be confirmed through excavation. These stands are on the NE side of the Ocote River (i.e. the SW side of EP) so it will be very interesting to see if the patterns follow the El Cupul pattern or if it is more similar to that of El Paraiso. It would be quite a surprise to see an EP pattern, but since these groups are on the EP side of the river, it is not inconceivable & it would answer significant questions about supply settlement for EP.

Sunday, June 14, 2009

We are on way of Salinas Spring to get permission from Jorge España to investigate sites 34-38. Had reached him by phone, but he wants to talk in person tomorrow, so will meet w/ him then.

July, 14 Jun 2009

2009-1-2

We are also happy to investigate both some of the smaller artifacts + the larger buildings that seem to be exceedingly well-preserved in the area N of Nasiriyah + W of EI Capital. The include sites in sites 6, 8, 9, + 7. One of the buildings has a very well preserved summit line visible.

We have also gotten the news that, after 12 years in the U.S., David Thelander's job is reeling so it will be necessary to move out of the lab here this summer. I will be very sorry to go, as it has been a wonderful house! I will consult with INAH + the municipality about moving the artifacts if there isn't a suitable place available for them here. If we can't find suitable here, we'll need to look at staying in EI Paraiso/La Florida or Copan. Both have benefits + drawbacks - will have to hash it out among all of the stakeholders. Right now, if there isn't any place the artifacts can be kept safely in EI Paraiso, I'm leaning toward having them go to La Florida the way they will be close by, undisturbed, + under Santiago's watchful eye.

Mon. June 15, 2009

Spent off looking for Tony Esper - still not found him - will try back later, the mound on to work on survey (getting started when they are needed). Will do EI Capital + the other sites back to EI Paraiso to work on the transition from the S-34-38 chapter

Both sites look fairly good - all EI Capital they cleared the fence zone of sites 1, 2, 3 + 4 + ploughed it w/ heavy machinery - earlier survey had shown it to be cleared

Monday June 13, 2009

2009-1-3

of Settlement, BA, if it had been ploughed before that would explain it. The rest of El Cofed looks to be pretty much undisturbed - the main plaza has been chopped, the Finca on Str. 5-8 remains to grow, but the Strs. on the ~~two~~ sides (1-3) are still clear (now under grass). The backfill all looks very good - in most areas it doesn't seem to have slumped much.

At El Paraiso we received the sad news yesterday that Don Pablo (Michael Pablo Berra) was killed over the weekend by a gang who, the gang goes, wanted his gun. The site itself looks good, although with fewer people than the opportunity for those who come to disturb the site increases.

This year, we hope to address the following research questions:

1. Nature of far rural settlement, especially that which can be considered in any way, shape, or form related to El Paraiso. To meet this goal, we hope to investigate sites 34-38, located N of town on the NE side of the Ocote. The current plan is to test 3-4 str. in each of the sites. We will look at:

- Ceramic materials
- Ceramic style
- Artifacts - imported vs local pottery
- Difference in use of space - W/O, human phosphate test support
- It is also possible that, since they are small rural str. we may find burials, which would be a great help.

2. Nature of small strata in El Cofed Sundry Settlement

- test 5m. strata between S-02 + S-09
- ~~bring~~ artifacts to see when they fell on carbon of imported local

Monday, June 15, (Cont.)

2009-1-4

3. Test notes of large sites. Visit El Cofre, in particular the very good presence of the summit architecture.
4. Trip partly - test pit on page in Solos and El Paraiso to see what pit, artifacts what to socially gathered can be found there.
5. Run into song - Defiance
6. Artifact analysis & cataloging.

Since we need to move the artifacts, if we do end up staying here, we'll need a good inventory - but it's less of an urgency to get all of the analysis done than there would be if we were taking them to Copacabana/ La Estrella where there is a good chance of the money and other materials.

For next year, greater oversight & advance prep will be important - there is a lot for one person to do & careful planning will be key.

By the end of the day, we managed to get 2 sites near Sta 12 at Site 007 (5701 is close to Sta 12) & a site on top of Sta 1 at El Paraiso. We also got permission to put a site by the water tower on Chiles Chales & are still looking for Jay Esparte. Tomorrow we will set pits on Don Ernesto's land - we got permission for him today.

Salvador + I will also all go tomorrow to Corbe his looking w/ us & to see if she will give the contract. My email to Salvador Varela at Copacabana about going to fly, so I'll try again tomorrow. Will also Corbe Vintas/Estiphanie to Salva

15 Jun 2009, Monday (cont)

2009-5

Sutcliffe also decided that he would like to do the test pits program in + around EP, so will go with that + try to get tomorrow.

16 Jun 2009 Tuesday

Still lucky for Jorge Espinoza to get off at the top of the day. EP Permit + getting pits at 5:07. Lost Miguel + looked at the map + saw that we'd initially divided 5:07 into multiple sites - it now makes more sense (as about on the ground + on the map) to give the a part of 5:07, so that's what I've done.

It's the end of the day + we're still lucky for Jorge Espinoza - He's trying to do sort of "warranty for budget" sort of thing - we will have things, may even, May + others (with Erik's help) have started at 5:07 + are really good programs - A really looks like they are going to have very well presented exhibits on some of the bigger buildings there.

Sutcliffe might to get a paper copy of a map of the Cardstock club for EP + will get the CAD club tomorrow. We can use that to update the test pits Sutcliffe wants in + around EP. I think this will be a very exciting program.

The rest of the students (well, almost all of them) arrive on Thursday + the house is just what really for them we need to get club to call for curtains/frames, etc.

16 June, Tues (cont)

2009-1-6

That's about it. I also need to make copies of the field manual for these plus together field kits.

Wednesday, 17 June 2009

Mary + Stefan continue at El Cafetal - Stefan is feeling a little under the weather + we'll need to keep an eye on her to be sure she isn't as ill as she was last year.

S-007

Stn 15 my bin a bin visible in the first unit + Stn 20 is yielding a large number of birds. off to a good job

The hunt for Jorge Espinoza continues - + it has taken an exciting turn. After missing him when he left camp yesterday, we stopped by his house this morning - only to see him speeding away on a 4x4. Sergio + Salvador are in hot pursuit + I'm in front of his house waiting for word from them. Jack excited.

18 June 2009

In SPS party up all of the stations - Evgenia arrived without any push + fell into the house. Jenn is in the lab worried us + evgenia else is in the blue house next to the orange house we had in 2006.

19 June 2009

Stations to the field for the first time. We started out with a tour of S-007 (Los Naranjos) where Stefan + my head started working the week before +



19 Jun 2009 (Wed)

2009-01-07

The mound on to El Cifal + El Pasion Base Sites look good + most of EP has now been cleared. Went back out to start Shanty in pits in the afternoon with Chely, Jaime, Nelson + Ryo.

20 Jun 2009 (Sat)

First full day of work for anyone - Chely for work at LA took a nap in the shade + was fine afterwards. Each student has begun excavating a Shanty + is paired w/ a worker. The plan works fairly well, although next time, it would be good to have a couple of unassigned "extra" guys to do things like fence building + tarp placement so the work would go more quickly. By not having 2 guys (at minimum) per Shanty, whenever the guys need to do something else, were effectively stops.

22 Jun 2009 (Mon)

A beautiful day but with fields, but <sup>(chilly)</sup> but foggy in the morning. I finished Shanty in the mid of the excavations (80 pits) + the students are curvy with the excavations.

Sick call: Juan (stomach trouble)

Workers: all present.

Will finish laying out a variety of excavations + I'll hope this will reduce the need for a lot of additional pit Shanty in the coming days. I can catch up on my notes.

Tuesday, 23 June, 2009

2009-1-05

Worked: All present, Lorena Mejia + Beto Centogama still today at my

Side Cell: none

Climate: Rained early this morning, very wet conditions, starting to dry, but  
Carro azul is kicking up clouds.

Sites S-36 + S-38 all good, wet, but good traps in place

S-007 - all good

S-038 +  
S-036

Starting off today in very wet conditions but hoping that it  
will dry out a bit. Of course given the amount of rain that  
fell early this morning (ended at approx. 1am) it may rain  
again. Ideally wish it were possible to look in there before  
the rains get back. Unfortunately there is another world of  
these sites as they are in very wet terrain I think  
it would take longer for them to become waterlogged  
but it seems to have taken only a couple of days  
for it to happen.

The sites are located along the 2<sup>nd</sup> terrace above the E  
bank of the Rio Ocoite, about directly across from the Piedra at  
of Los Ocoites. They form part of a bed of settled dry  
the terrace + are composed of stone + earth structures arranged  
and a single patio. S-038 includes 5 clear structures +  
one low rock scatter that might be part of another structure  
arranged and an open patio while the exact content of the  
structures may await excavation. They appear to be fairly intimately  
arranged

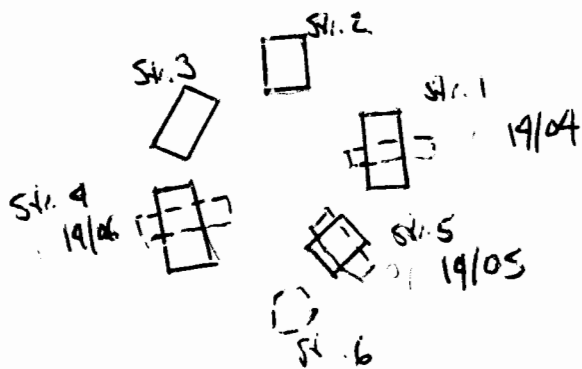

Tuesday, June 23 (cont.)

2009-1-5

S-038 We have opened excavations on 3 of the 5 clearly visible streets:

Stk. 1. Op. 14/04, Pego-Johnson (#91)

Stk. 5: Op. 14/05, Michelle "Miki" KANA (#40)

Stk. 4: Op. 14/06, Catalina López (#39)

The excavation goals here are:

1. Test Streets to confirm that they date to the Late Classic
2. See if pottery falls EC or EP path (ie utilitarian - common)
3. See if truly local sites have a different material culture signature from their Great E.C. (more elite)

So far, we have excavated a lot of pottery + other artifacts. It looks as if, as expected, the sites were local households + that they seem to have used local pottery almost exclusively (as observed informally in the field prior to work). The Squares will work with the hypothesis that only residents of El Paraiso itself used pottery imported from elsewhere.

We have not yet found much architecture as (1) all of the buildings are fairly low + (2) work is progressing slowly as foundations are built.

S038  
St. 4 Op. 14/06 This is one of the two largest streets along the west side of the site, opposite the steep drainage from S-036. It is being excavated by Catalina +, so far, there is a suggestion of a cobbles surface on the public side, but nothing that is very clear. It may just be rubble that fell onto a flat

Tuesday Jan 23, 2001 (cont)

2001-110

S-038 Spec E of the structure. Consider decided to open up the first Str. 04 (cont) 4 units along the E-W axial track to view/expose the track + in EUC (summit) you find a zone of large flat rocks that may have been part of a small surface + sand as the base/floor of the superstrata. There is now open up a 4th unit to the E to check the track - run for open. There were a couple of lines of very small rock that looked promising as well but as work continues it seems more likely that they are tracks + that the potential lines were artifacts of excavation.

S-058  
Str. 5

Op. 14/05 Excavated by Mike (#40) This is a very low structure that almost looked like a simple scatter of rocks on the surface in the first EU. However, a short clapnet smashed into a number of brisquaque was uncovered. This has been left in place + Mike is opening EUB (to the W) in order to expose more of the deposit. It is very slow going as there is a lot of water coming up from below.

S-054  
Str. 01

Op. 14/04 Excavated by Ryan (#41) This is one of the 2 largest structures on the site (with Str. 4 by the other). Again, the structure was marked out 40m by 40m in the first EU + Paul is now using a track to the South. The track seems to have missed the axis (visible after clay + excavate had begun) so will re-orient + will run more E-W over what we hope is the axis.

All of the structures on this site are pretty a lot of putting + it will be important to examine it at least in a preliminary way in the lab. Eugene will visit on Saturday (when I go to La Estada w/SPS to get Laura + Willie)

Tuesday, Jun 23, 2009 (cont)

2009-1-11

S-036

The site is located directly along the 2nd terrace of the Ocoee River. A falls on a small spur of land that juts above the lower terrace. The site is comprised of 7 structures, 5 of which are clearly visible + one of these is located on its own to the north (Str. 7). The additional structures (Str. 5+6) are rock scatterings barely visible on the surface. The site seems to be slightly larger than S-038, with its main structure (Str. 1) being the highest + most massively built structure at either site. The stone here also seem to arranged more regularly, so it will be interesting to see if there are any differences (significant differences) in the organization, material culture, + construction of the two.

Str. 7

14/01 City (345)

↑ N

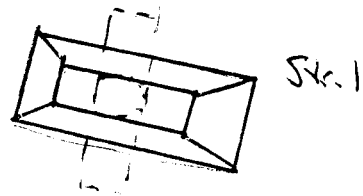
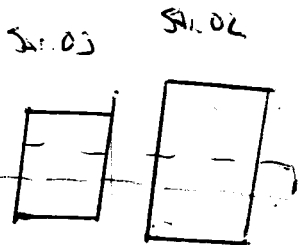

14/02  
Junin (342)



14/07  
Sel- (338)

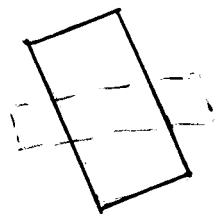

Str. 4



Str. 6

14/03

Melissa (344)

Tuesday, June 23, 2009 (cont.)

2009-1-12

S-036  
Sta. 01

Op. 14/01 Excavated by Chelcy Phily (#45) + Leonard. We went  
plumb the trench up + saw the 1-5 Basis of the Shale, Shypping the  
large luster's pit in the center. Excavate here on the N side of  
So far, Chelcy can't find the hole looking for the wall. Some  
P.A.S., but not as much as in other tracks has been found

S-036  
Sta. 06

Op. 14/06 Excavated by Melissa Morris + Tim. This is a very  
low site with only a few rocks visible on the surface. No  
hammer, or even a hammer a long and of pottery has been found.  
Looking at the scattered rocks visible on the surface, it makes  
me wonder about all of the stone visible on the surface  
at S-007 - could all of that come from similar sources?  
This unit is also filling rapidly with water, undraining the lower  
clastic

S-036  
Sta. 04

Op. 14/07 Excavated by Stefan (#38) + Peter. The Shale is on  
of the 3 layers at this site (at Sta. 1 + Sta. 2) it's on the ground  
to be a 1/4th off + we're coming out of the side. Stefan  
is going to define the wall so that we can see when  
the Shale fits

S-036  
Sta. 02

Op. 14/2 Excavated by Tim<sup>senior</sup> + Cleve. This Shale reveals  
a fully clean wall line + an artificial deposit with a large  
mass of quartz (approx. half of the mass is quartz) and a small  
Greenstone (serpentine)

Thursday 25 2001

2001-1-13

Back in the field after an exciting day yesterday (Wed. 24 June)  
I went to the bank in La Cruz with the students while I was  
morning at 5-036 + 5-038 with the students while I was  
gone. It was a very productive day there - a "good find" which  
was found in Op. 14/09 by Ryo, Str. 1, 5-038, Chely got the  
N bed well on 5-036 Str. 1, + Jane for material to the W side  
of Str. 3, 5-036. Catherine has also found her find over 5-38  
Str. 4. More details on each below.

I should also note that, after 3pm on Tuesday, June 23, Jorge  
España, the owner of the land came out + expressed his  
interest with the fact that we were using traps to cover  
the excavations + provide shade while digging, saying that they  
looked like an "invasion". He was also worried that we were  
digging larger holes than he thought we would, despite the fact that  
these excavations are much smaller than those we've done elsewhere  
in the valley. Jorge España was fed up from the beginning (why not  
talk to us), + this is a constraint of the situation. In the  
end, he gave us permission to continue through the next  
week. We'll work slight through until the Copal top to finish  
+ the fins on the lab work. As long as we're able to stick to  
this schedule, we'll be fine. It would have been nice to  
get more done here, but, in the time frame we should be  
able to get what we need for these sites. If the schedule  
changes - i.e. he tries to move us off earlier, then we'll need  
to get support from the Municipality + Instituto.

Back to the end of wed. At 5-007 (Los Nangos)  
my find a whole vessel covered under a small, shallow  
series of basins on Str. 20. A series to have been found in a  
very shallow (less than 20cm deep) depth that was found by

25 Jan, 2009, Thursday (cont).

2009-1-14

S-036 - Site Survey to date:

Str. 01 - This is the largest of the; it is oriented (most likely) at about a few degrees S of E + faces South into the Small central plaza. The back (W) wall has been defined + it includes approximately 3 rooms. It needs to be cleared up a little. The front (S) side is now by investigation. The top includes a large vertical hole. This is the largest Str. at S-036 + it rises at least 1.5m (if not more) above the plaza. It has S as the primary axis to anchor the group.

Str. 02 + Str. 03 - These buildings are located on the W side of the Plaza + Str. 2 runs into the plaza itself, with a wide, low front terrace. Str. 3 is located directly behind (W) of Str. 02 + excavations are early to define its orientation. There is a lot of hydraulic work off the W side of Str. 03, suggesting a collapsed structure wall. There has also been some work - the pottery fragments (but Spanish red paint) long out.

Str. 04 - This is the 2nd largest of the buildings at the site + it appears to run N into the plaza as well. The back wall on the N side includes 1 low curved wall + a lot of rubble on top of it. A lot of ceramic rim band fragments have been found in the clay surface N of the Str. 04, suggesting that there was a Paucabani occupation in the region (ie. same pattern as with the Str. at El Ajupul). A similar rim was found at S-038, Str. 01, but the rest of the ceramics are Chuy Lake Classic.



Thurs. 25 June 2004 (cont.)

Zoe 9-1-15

Str. 06 This is a very low building that appears to have been quite blown out. It is almost completely flat, it was just visible as a scatter of rocks on the surface + the "platform" feature is visible ~ 5m x 20m approx. There are a lot of pottery fragments + byzantine fragments here as well.

Site 038 Update This group is located E of S-036 + further up the slope. This is a smaller site/group than the site down slope. It includes Struts + we are missing only 3 of them. Struts 1, 5, + 4.

Str. 01 This is one of the 2 high Struts at the Site (The other is Str. 04). This is the first one in which we were able to see good wall lines. The structure appears to be oriented approximately N-S + faces (as far as we can tell) West. The East wall, however, is only preserved to 1 course high. The fill appears to be very disturbed + the building may have been disturbed by agriculture. There is almost no difference in soil between the fill + fill.

Str. 5 This is a very low building that appears to be oriented on a SW-NE line + face diagonally into the patio. One line of fine stones to be present in the E basal wall. A lot of byzantine was found near the base of the E wall + this was mixed with pottery.

Str. 4 This is also a large Strut - perhaps the largest + certainly the best preserved on site. The building is oriented N-S (approx) + faces E into the patio. There are 2 terraces leading up to the summit, a sand floor/bed filled by large stones (E wall).

Thursday 25 Jun 2009 (cont.)

2009-1-16

in the central trench), & a rear wall (1 course) with a  
8th day on the W side. It has to be seen if both  
Sides of the structure had terraces - a possibility for the  
the building is the first reached along the access route  
for site 36 & may be beneficial for a road access.

Friday, 26 Jun 2009

Ryan in sick today - found issues + fever, gone home Cipri

Nemo is working at MIRA + I'm doing Ryan's shift (Str. 01, 5135)  
Simon is still here.

Drawings Completed:

S-038, Str. 01, Op. 14/09, E Wall of trench  
S-038, Str. 01, Op. 14/09, S Wall of trench  
S-038, Str. 05, Op. 14/05, N Wall of trench

Saturday 27 Jun 2009

Liam Hazel + Mingy will be in today - Jim  
will pick them up at the airport, drive them to location  
& they will bag them out to El Perote this afternoon

On-site at S-036 + S-038 study in points + drawing.

Thurs, June 25, 2003 (cont.)

2003-1 - 19

A very small set of glauca cache box of Sorko. We're lucky if it makes the index to S007 for the elite compared with the great site of the main Srp at El Cephal, given that it is just W of the junction between the re-built elite Srs. 607. The fact that S-007 Str. 12 is actually quite well painted (rather than by a blue or a fudge that had been used) suggests that the area was an extension of the elite residence on the W side of the EC main Phylon.

The vessel itself will be described below. Regarding the way that the dirt had to come and the R.D.s at Cap, My & I examined the interior of the vessel & checked the outside very carefully & worked. It looks like a Copal or Gualpapa type vessel with a band of pseudopyro along the top & a set of 3 Kinky figures with the heads held up in front of the wall (clear more today (but was done at night so the details were difficult to see).)

Today I have the machin-out at S034 + S038 + will start on pits + architecture today.

S-036 Op 14/07 Srp - Pass here find the N wall, may be the Str. 04 NEC as well - pits out on it.

S-026 Op 14/01 - find but wall; definitely not for N (back wall)  
Str. 01 Op 14/02 - mud to back (W) wall

Saturday 27 Jun, 2009 (cont.)

2009-01-18

5-036

A lot of very good progress today - especially on Stron 1 & 4  
Str. 01 Also a very well painted wall on the S side -  
it may be an extra deck as it was covered with very large  
fall stones (huge boulders)

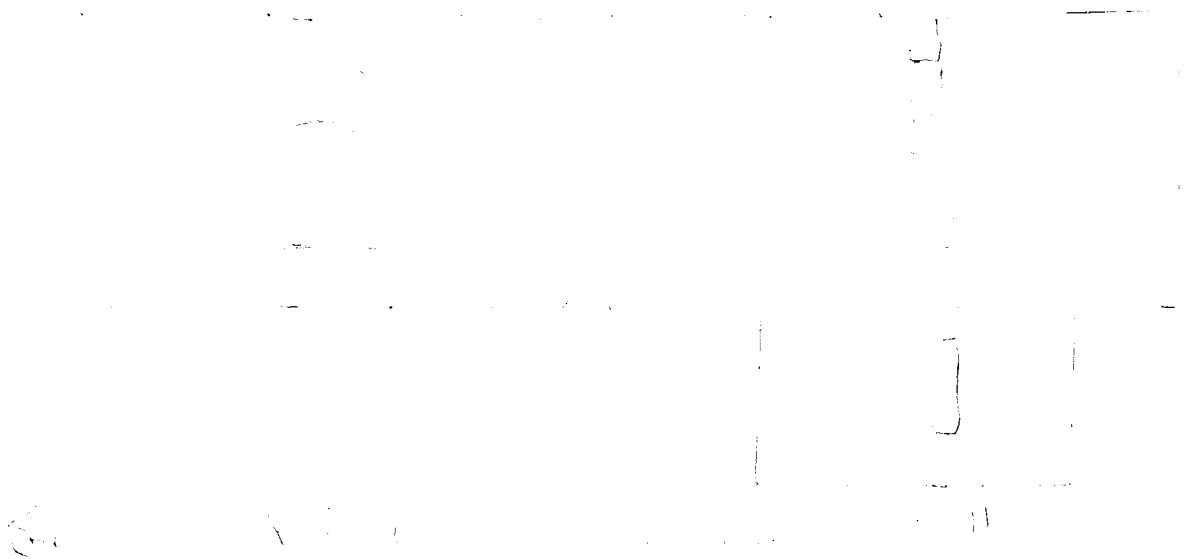

Sunday 28 June 2009

2009-1-19

Even though today is Sunday, we did do some field work - I was out to S-007 with Mary Jean, + Mary Fred with to Street Pln points on Jct. 20. I think they Salvadoran Jct. told us that the Princes of Asturias Mel Zelaya had been forced into exile in Costa Rica. At this point, everybody has talked with El Paraiso all of the (students) Carolyn, Beth, + Paul at CSU think that we are fine - All the point, Zelaya has been ousted, the Princes of the Congress, Melillo, has been sworn in as the new President. So far the data seem to have been much support for Zelaya, but will see what tomorrow brings.

As long as I'm with field notes (+ sketches the complete), here is an update:

S007 - My has moved to clear a good portion of Jct. 20 (see the notes & sketch) + it is now being to resolve into a rather interesting series of connected lines, or an open enclosure.

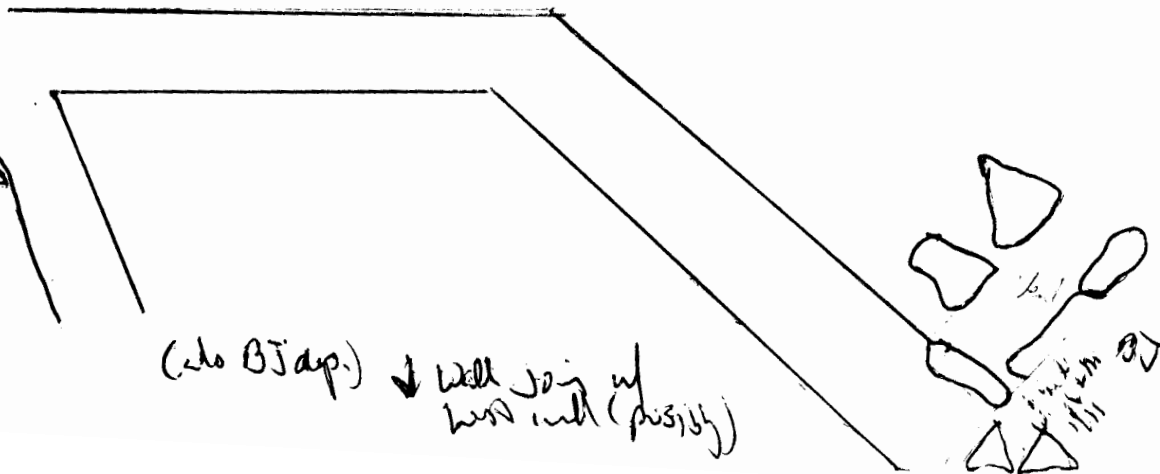

(also BJap.) ↓ well join up with (possibly)

28 Jan 2009, July (cont.)

2009-1-20

S036 Str. 01 The body in space of a large tapered hole in the cuty. indicates a well-preserved back (N) wall, a well-preserved W panel wall, a low but somewhat pointed band/beam wall on the front (S) side +, approx 3 m N, or my well preserved wall just as could with the top building. The suggests that it was either part of an earlier version of the structure, or that the ground level of the front region of the building was perhaps a least 1 m (or maybe more. It seems to be seen) into the FAN of the structure. There was also a large jar found at the base of the W panel wall - photo taken in 2010 (14/01/10 EUS) on the floor. The front panel was for Lake Clinic had used in just with a horizontal tube bulk.

pin...  
...  
...

4



114 2009 Estimation  
Jorge Espinoza  
Rural Sim Proj



# S-036

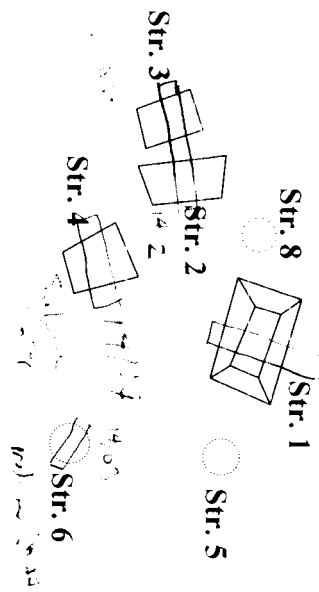

# S-038

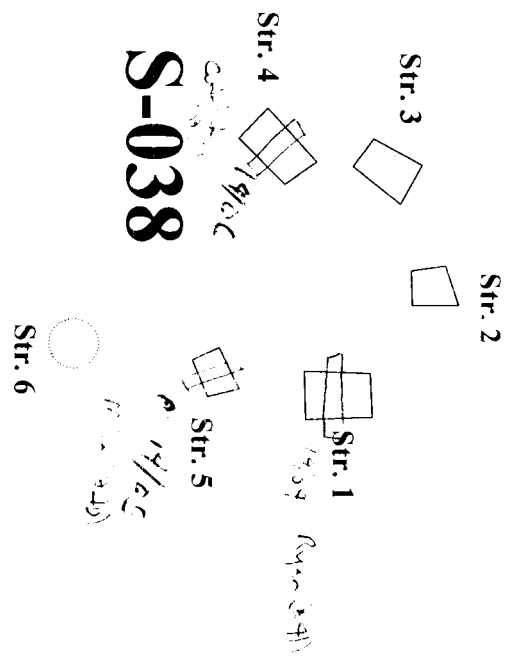



02/05  
02/08

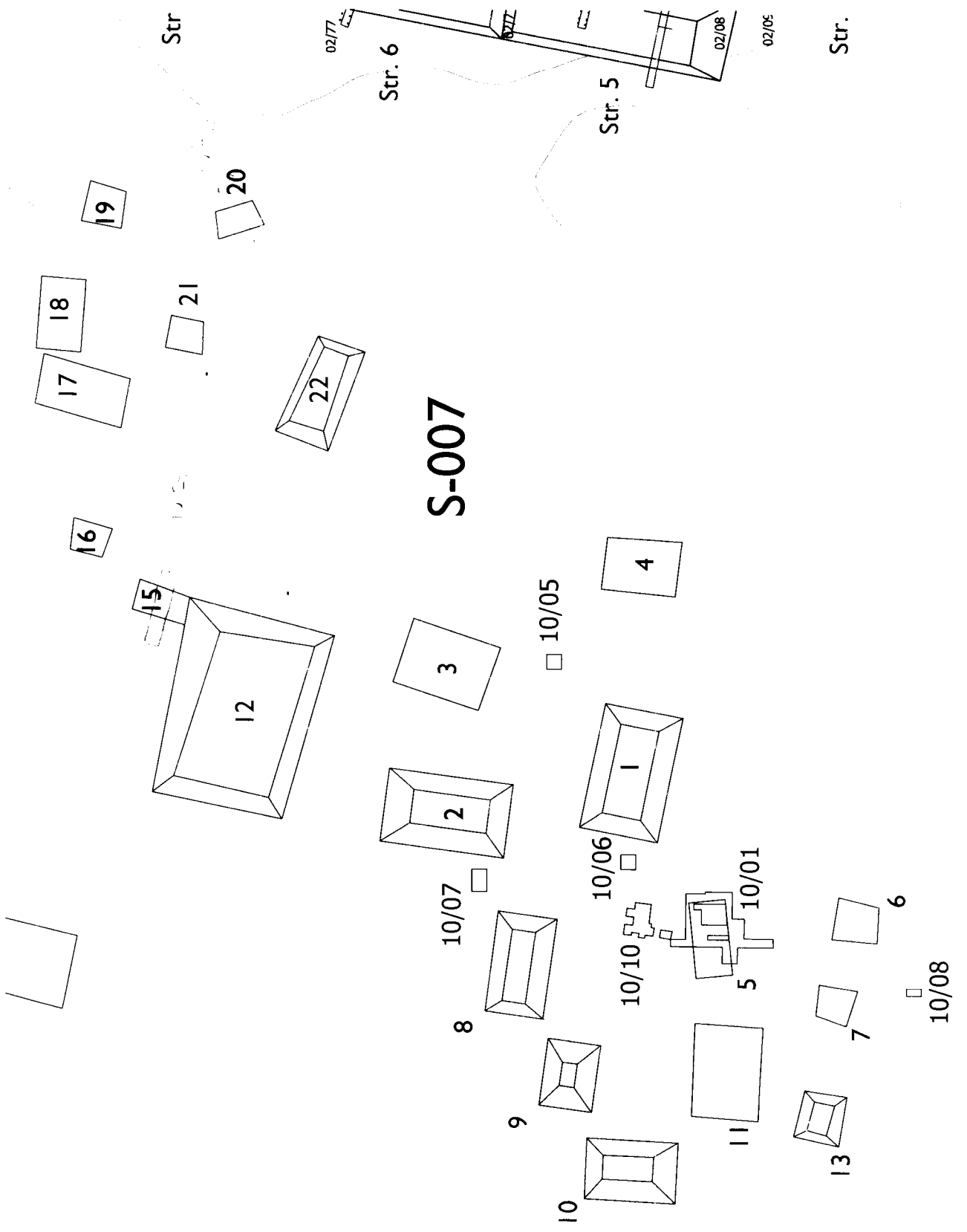

Str.

Str. 6

Str. 5

S-007

Str.

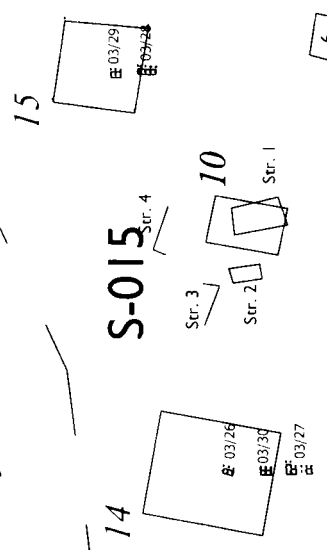

# S-006



# S-008

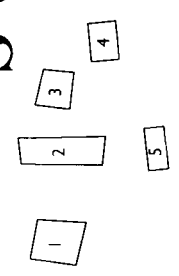

# S-009

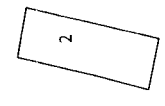

# S-007

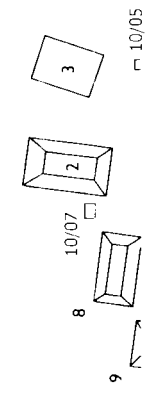

# S-002

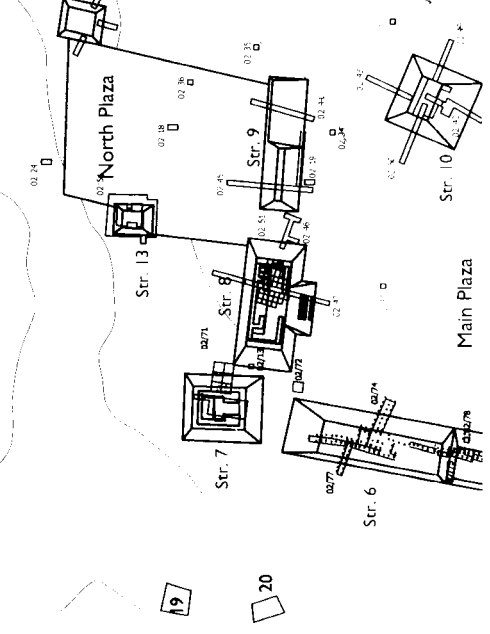

2



10/07

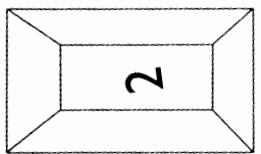
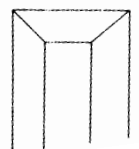

2

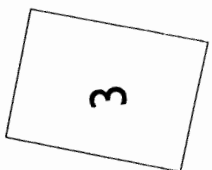

3

□ 10/05

# S-007

12

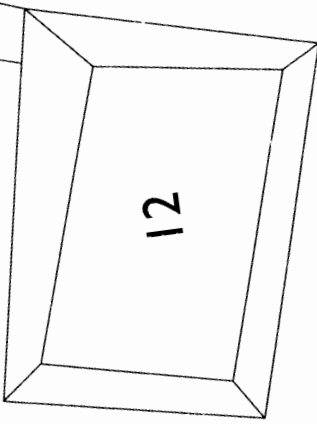

15



10/25

16

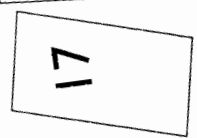

17



18



21

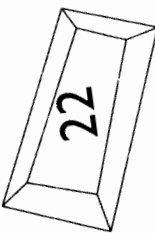

22

20

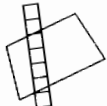

10/26



19

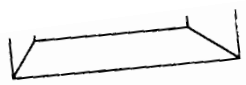

Str. 7

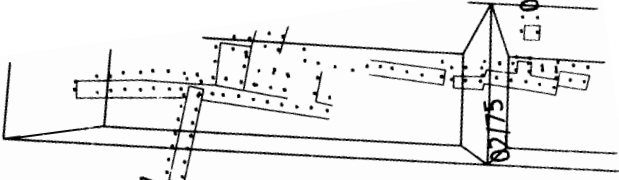

02/17

Str. 6

02/15

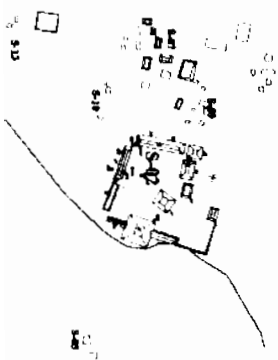
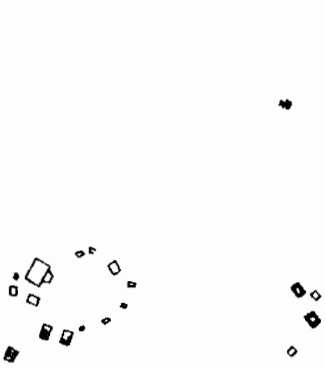

S-33

S-34

S-33

S-34

S-33

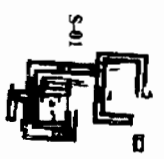

**Valle El Paraiso: Zona Recinto**

- Material structure
- Area
- Road
- Central courtyard
- Peripheral courtyard
- Public courtyard
- 1m contours

Mag. N

0 100 200 m

# S-036

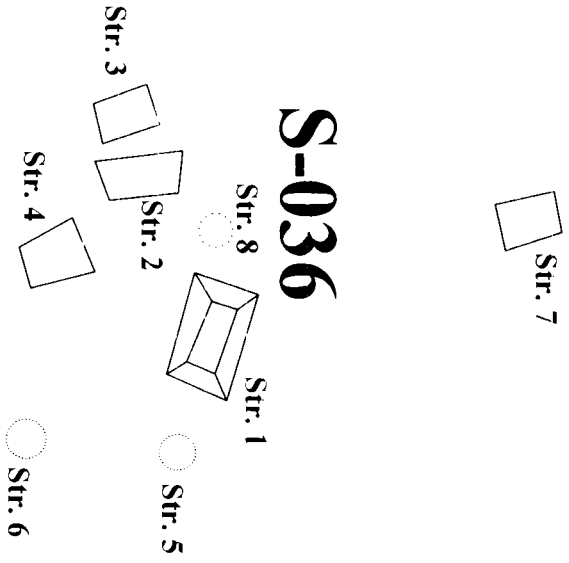

# S-038

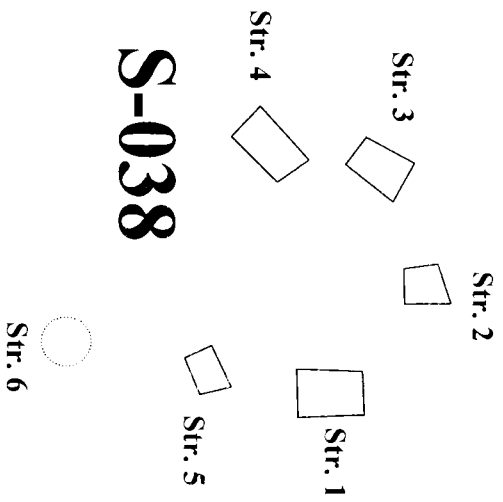

# S-036

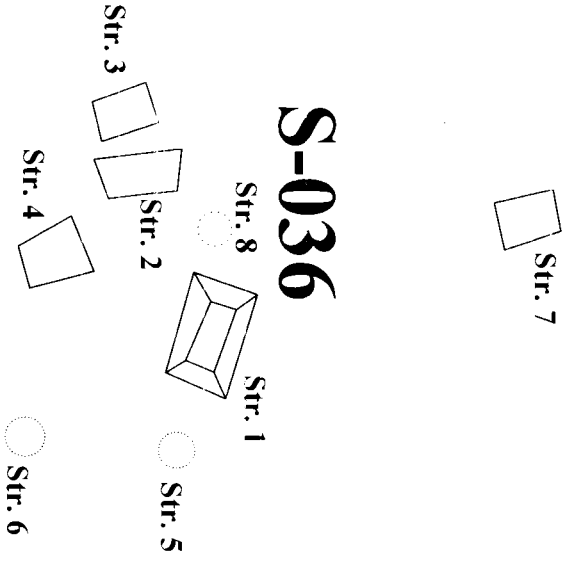

# S-038

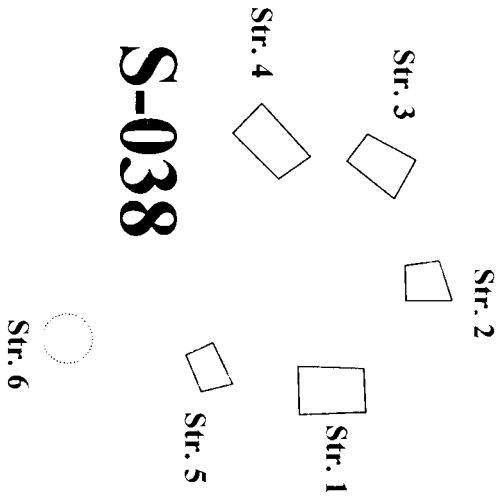

Thursday June 17, 2004

2004-1-10

Back to the S230 survey area along N side of town, pushing W to the high terrace on the E side of the Ocoté River. Still at S231 which may or may not be 0 at - there were back-sight / foresight issues while setting it yesterday. Work of Tulio + Roberto today.

The land here belongs to Juan España, whose son stopped by yesterday. The mayor had sent out letters in previous years asking for the celebration of landowners in the valley + we explained that we're doing the same work as last time. We should have gone to talk to him first, but it just didn't occur to me to do it. I invited him to see what we're doing at the site in town. Marcelo + I can stop by + pay him a visit later in the week if needed.

We just moved a huge, 3-legged bull out of the way of the back-sight. It really was a sight to see - poor thing hobbles along on 3 legs. He was apparently born that way, the story goes. My horse wanted to buy him, but Don Juan doesn't want to sell.

Problems w/ the vertical again - orig vert. error = -0.09. Checked this in mirror. We're about the width of one mirror above over a distance of 250 m.

06-17-2004 point log

S231 = occupy pt.

S232 = shot for S231, stake in lg. beautiful open field S + W of S231

Thursday, June 17, 2004 (cont)

2004-1-11

Site 37 - Single str. NW of 5231, in very high sand (but the thin, fine stuff that comes to end waist, not the <sup>0.50m</sup> <sup>downy</sup> grass that towers over one's head). Str. appears to be oriented N-S. There may be other strata, it's just impossible to see them. Shale down to Ocotillo River. Area: Jr - Esperia. Evident in db

Friday, June 18, 2004

Cont'd top map & orientation survey along the N1400 line, past W to River Ocotillo. Located / confirmed Site 38 - at least 4+ possibly 5 str. located along 2<sup>nd</sup> from edge.

Site 38 4-5 strata grp. located along edge of 2<sup>nd</sup> from on E side of the Ocotillo, approx. 50m <sup>E</sup> across a ~~small~~ ravine from S-37 low runs of cobbles, small washed grp.

↑ N

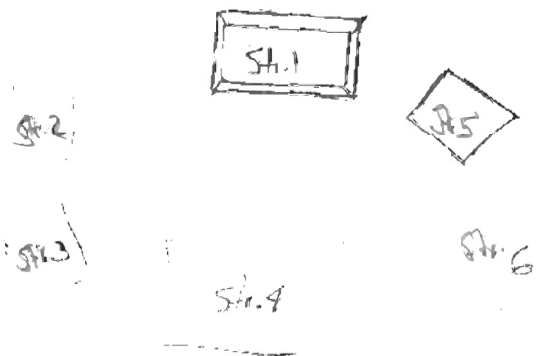



Date	Point #	N	E	Z	Description	Attributes		
6/17/2004	1	1519.696	117.5643	990.738	S-037 M001 NEC	Construction	Ancient	Structure
6/17/2004	2	1519.248	112.9558	990.4862	S-037 M001 NWC	Construction	Ancient	Structure
6/17/2004	3	1512.184	117.321	990.8384	S-037 M001 SEC	Construction	Ancient	Structure
6/17/2004	4	1512.234	112.6922	990.5723	S-037 M001 SWC	Construction	Ancient	Structure

Fri. June 18, 2004 (cont.)

2004-1-12

~~S-038~~ Group with 3-4 strata, one of which is over 1m high (prob. close to 1.5).<sup>20</sup> The strata include a large looter pit on top of it. The str. to the W includes either a low terrace on the W. side or is flanked by an adjoining low strata. Another str. is put to the South, but there are no associated cobbles. It is possible, however, that the str. was an earlier (i.e. preclastic) built up about which the LC upper group was constructed. S-037 is approx. 50m W of S-038 across a slight ravine that appears to carry flow seasonally/intermittently.

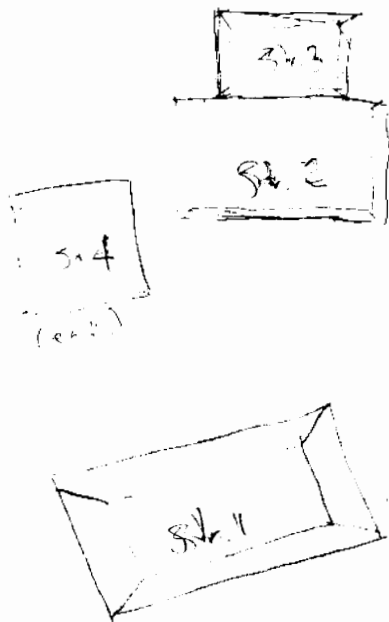

Friday, Jun 18, 2004 (cont)

2004-1-13

S-035 site w/ 2 groups located N of Site 36 (which is the site of the 15-2m str. with a loess pit) along the edge of a slight rise or the eroded remains of the 2nd terrace on the E side of the Ocoke River.

Monday, Jun 21, 2004

Topo mapping in N zone (S233, S236, S237). See daily map for details. Assisted by Tulo, Salvador, + David - Roberts to SDS + Teyra for week. Finished the E border up the N1400 line.

Tuesday Jun 22, 2004

Back at S237 to shoot in str. in sites 35, 36, + 38. Working first on site S-36. This is the site of the 2m. mound w/ the loess tent on top. In mapping the site, I realized that the app. to be 5 sites. (more the pre-eroded sand). The sites were mapped w/ the following numbers

File: 06-22-2004

S-036

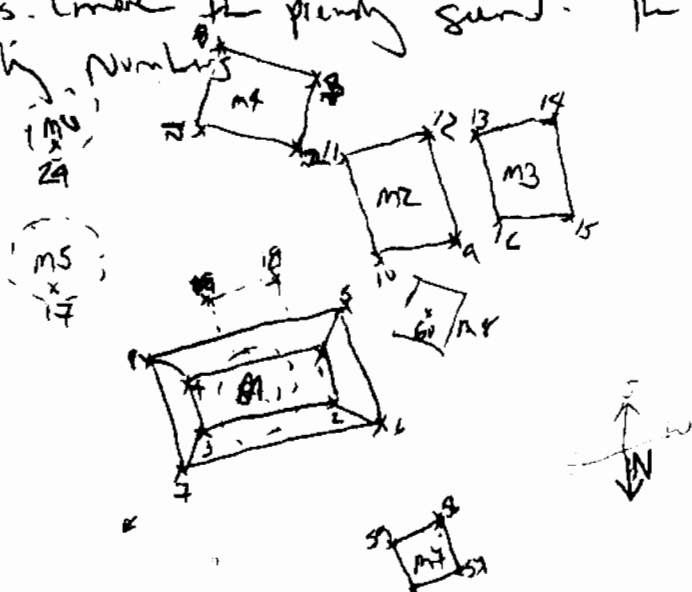

Site 1 may have a terrace or site off the S. side (shown as 2 pts. that extend to the main str. ( ) M3 may or may not be attached to M2

2009 Red Sites Program

4N

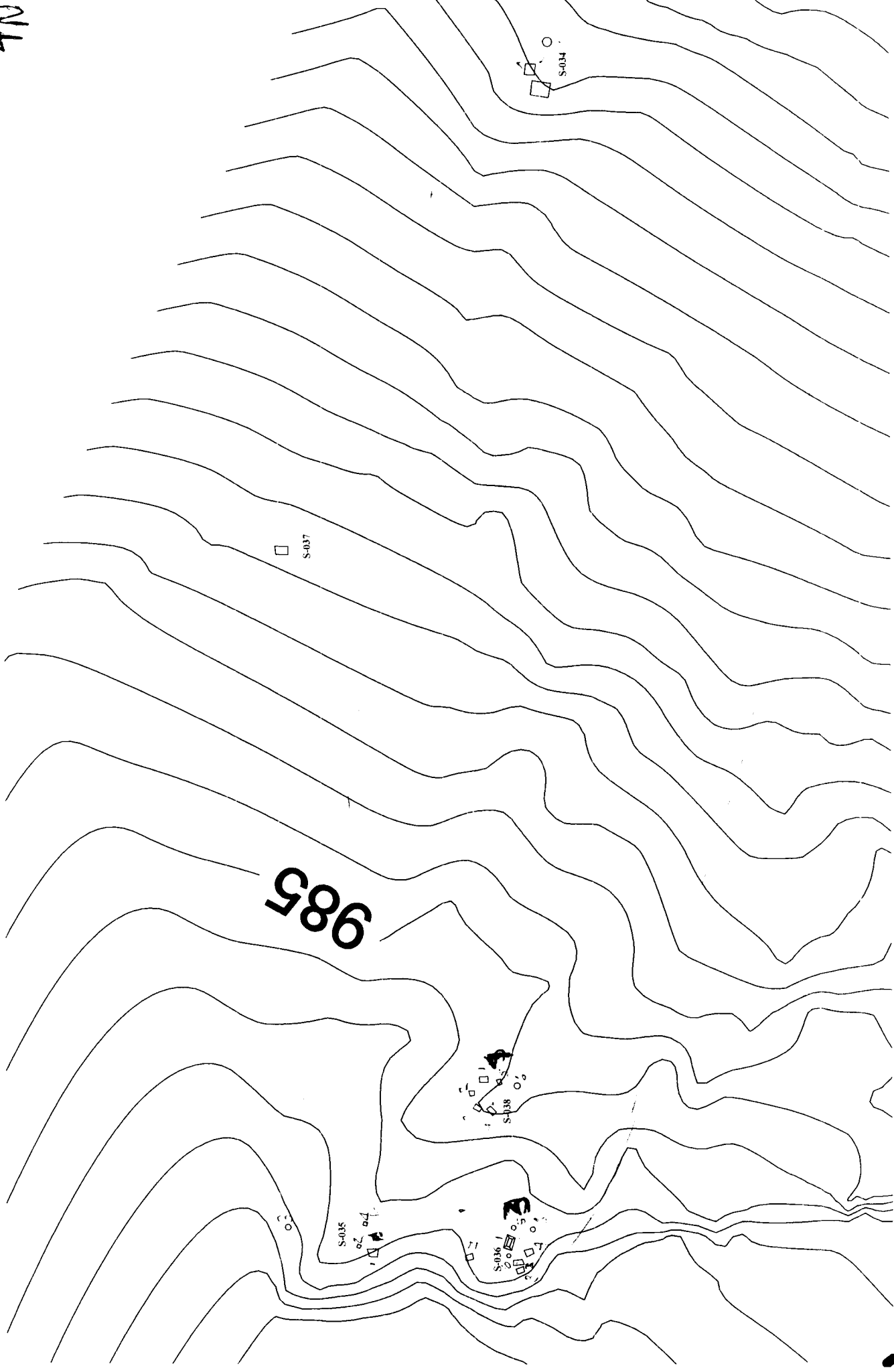

500 400 300 200 100

Tuesday, June 22, (cont.)

2004-1-14

S038 Site located  $\leftarrow$  of S036, separated from it by a shallow ravine

$\uparrow$   
T 5-36 (cont.)

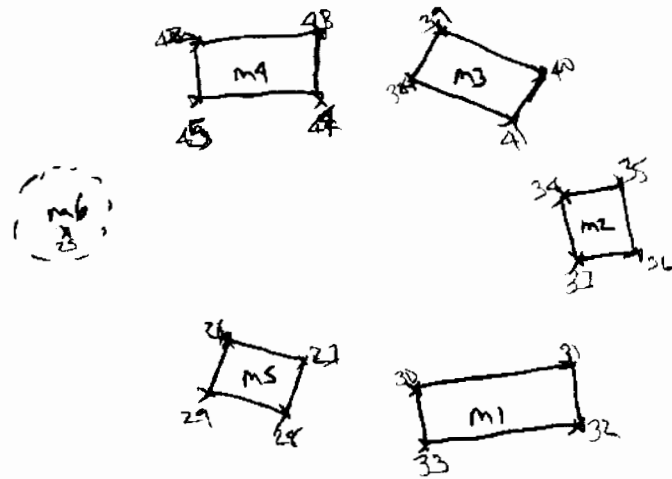

5 visible studs & one raised area w/ rock (M6). The sites S + E. All are low, very open to low but very robust

S035 Site on edge of hill that E the de facto N. part of the E. Bank. Site includes 2 groups, but, today, I could only locate 3 studs. w/ rock. The N group makes a layer elevated to the NW but there are N rocks. Only able to take 1 pt. SW of site 3 - tree blocky



29 June 2009, Monday

2009-1-21

S-035 Sta. 4 Potzook on W wall just S of Sta. middle  
A looks like a big local jar w/ a drop back.

↑

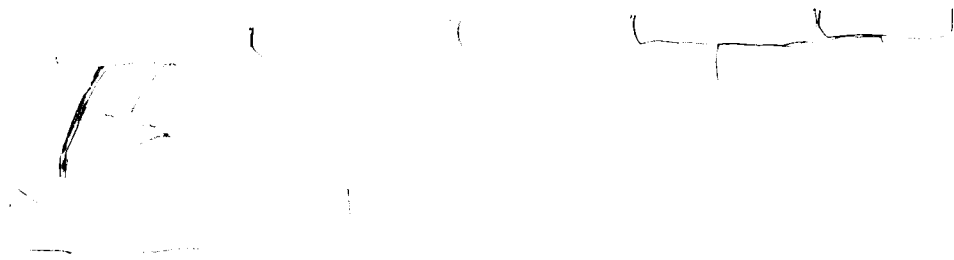

30 June

Finished exams at 4:30 in the middle of  
a breezy rainstorm.

1 July - 5 July - Cape Trip

6 July - 12 July - Lab work